

System Administration Guide

701P42722_EN



Prepared by:
The Document Company Xerox
GKLS European Operations
Bessemer Road
Welwyn Garden City
Hertfordshire
AL7 1HE
ENGLAND

© 2004 by Fuji Xerox Co., Ltd. All rights reserved.

Copyright protection claimed includes all forms and matters of copyrighted material and information now allowed by statutory or judicial law or hereinafter granted, including without limitations, material generated from the software programs which are displayed on the screen, such as icons, screen displays, looks etc.

Xerox[®], The Document Company[®], the digital X[®] and all Xerox products mentioned in this publication are trademarks of Xerox Corporation. Product names and trademarks of other companies are hereby acknowledged.

The information in this document is correct at the time of publication. Xerox reserves the right at any time to change the information without notice. Changes and technical updates will be added in subsequent editions of the documentation. For the latest information go to www.xerox.com.

Table of Contents

Table of Contents	3
1 Before Using the Machine	9
Xerox Welcome Center	9
Conventions	10
Related Information Sources	11
2 Product Overview	13
Identifying the Machine Components	13
Power On/Off	14
Powering On	14
Powering Off	14
Cabling	15
Interface Ports	15
Modes	16
Copy	16
Fax	17
E-mail	17
Log In/Out	17
Job Status	18
Machine Status	19
System Controls	25
System Settings	26
Changing the Settings	27
Ethernet Port	28
Resident Fonts	28
PCL Resident Fonts	28
Symbol Set	30
3 NetWare	33
Information Checklist	33
NetWare Environments	34
NetWare Installation	35
Installation Procedure	35
Network Communication Setup	35
NetWare Setup	37

Workstation Setup	37
Test Print	37
4 UNIX TCP/IP	39
Information Checklist.....	39
UNIX TCP/IP Environments	40
UNIX TCP/IP Installation.....	40
Installation Procedure.....	40
Network Communication Setup	41
Workstation Setup	42
Test Print	47
Printing	48
Solaris/HP-UX	48
SunOS	50
Printer Status	52
Solaris/HP-UX	52
SunOS	53
-C Option.....	54
5 EtherTalk.....	59
Information Checklist.....	59
EtherTalk Environments.....	60
EtherTalk Installation.....	60
Installation Procedure.....	60
Network Communication Setup	60
Workstation Setup	62
Test Print	62
6 Microsoft Networking	63
Information Checklist.....	63
SMB Environments	64
SMB Installation	65
Installation Procedure.....	65
Network Communication Setup	65
Workstation Setup	67
Test Print	67
Changing the Settings.....	68
Procedure	68
Setting Format of config.txt.....	69

7 TCP/IP (LPD or Port9100)	71
Information Checklist	71
TCP/IP (LPD or Port9100) Environments	72
TCP/IP (LPD or Port9100) Installation	72
Installation Procedure	72
Network Communication Setup	73
Workstation Setup	75
Test Print	75
8 Parallel Port	77
Information Checklist	77
Parallel Port Environment	78
Parallel Port Installation	78
Installation Procedure	78
Parallel Port Communication Setup	78
Workstation Setup	79
Test Print	79
9 USB Port	81
Information Checklist	81
USB Port Environment	82
USB Port Installation	82
Installation Procedure	82
USB Port Communication Setup	83
Workstation Setup	83
Test Print	84
10 IPP (Internet Printing Protocol)	85
Information Checklist	85
IPP Environment	86
IPP Installation	86
Installation Procedure	86
Network Communication Setup	87
Workstation Setup	88
Test Print	88
11 CentreWare Internet Services	91
Information Checklist	91
CentreWare Internet Services Environments	92

CentreWare Internet Services Installation.....	93
Installation Procedure.....	93
Network Communication Setup.....	93
Test Access.....	94
Using CentreWare Internet Services to Configure Settings on the Machine.....	95
Ethernet.....	95
Parallel.....	96
USB.....	96
EtherTalk.....	97
SMB (Microsoft Networking).....	97
NetWare.....	98
TCP/IP.....	99
LPD.....	100
SNMP.....	101
IPP.....	101
Port9100.....	102
UPnP.....	102
E-mail.....	103
HTTP.....	104
12 E-mail.....	105
E-mail Overview.....	105
Scan to E-mail.....	105
Mail Notice Service.....	105
Information Checklist.....	105
E-mail Environments.....	106
E-mail Installation.....	107
Installation Procedure.....	107
Network Communications Setup.....	107
Test E-mail.....	109
13 Problem Solving.....	111
Problem Solving Procedures.....	111
Problems using a NetWare Environment.....	112
Problems using an SMB Environment.....	117
Problems using a UNIX Environment.....	119
Problems using a Windows Environment.....	121
Problems using EtherTalk.....	124

Problem using CentreWare Internet Services	125
Problem using Mail Notice Service.....	127
14 Glossary	129
Terms Defined.....	129
15 Index	133

1 Before Using the Machine

Welcome to the Xerox family of CopyCentre/WorkCentre products.

This System Administration Guide provides detailed information, technical specifications and procedures for using the integral features of the machine.

Xerox Welcome Center

If you need assistance during or after product installation, visit the Xerox web site for on-line solutions and support.

<http://www.xerox.com/>

If you require further assistance, contact our experts at the Xerox Welcome Center. A local representative telephone number may have been provided when the product was installed. For convenience and future reference, please record the telephone number in the space below.

Welcome Center or local representative telephone number:

Xerox US Welcome Center: 1-800-821-2797

Xerox Canada Welcome Center: 1-800-93-XEROX (1-800-939-3769)

When you call the Welcome Center you will need the serial number which is located on the left side of the machine behind Cover A, as shown in the diagram.

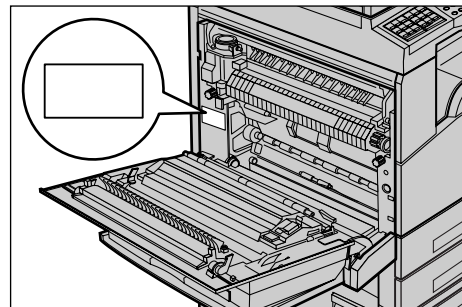

For your convenience, record the serial number in the space below.

Serial Number:

Keep a record of any error messages. This information helps us solve problems faster.

Conventions

This section describes the conventions used throughout this System Administration Guide. In this guide, you will find that some terms are used interchangeably:

- Paper is synonymous with media.
- Document is synonymous with original.
- Xerox CopyCentre/WorkCentre 118 is synonymous with the machine.

Key Operator

Key Operator describes the person who is responsible for hardware maintenance.

Orientation

Orientation is used to mean the direction of images on the page. When the image is upright, the paper (or other media) can be either long edge feed or short edge feed.

Long Edge Feed (LEF)

When loading documents long edge feed into the document feeder, load with one of the long edges facing into the document feeder. The short edges appear at the top and bottom of the paper, facing the front and back of the document feeder. When loading paper long edge feed into a paper tray, place the paper with one of the long edges on the left hand side and one of the short edges toward the front of the tray.

Short Edge Feed (SEF)

When loading documents short edge feed into the document feeder, load with one of the short edges facing into the document feeder. The long edges appear on the top and bottom of the paper, facing the front and back of the document feeder. When loading paper short edge feed into a paper tray, place the paper with one of the short edges on the left-hand side and one of the long edges toward the front of the tray.

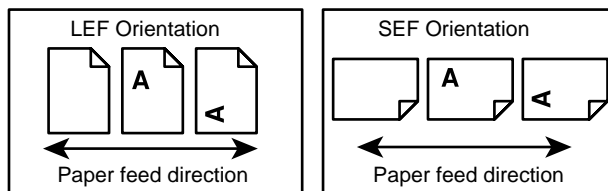

Text in [Square Brackets]

Indicate that these are names of the screens, tabs, buttons, features and option categories on the screen. They are also used when referring to file and folder names on a PC.

For example:

- Select [Original Type] on the [Image Quality] screen.
- Select [Save].

Text in <Angle Brackets>

Indicate that these are names of the hard buttons, numeric or symbol buttons, lights on the control panel or symbols on the power switch label.

For example:

- Press the switch to the <I> position to switch the machine on.
- Press the <Log In/Out> button on the control panel.

Italic Typeface

The Italic Typeface is used to indicate references to other sections and chapters.

For example:

Machine Status – page 20.

Cautions

Cautions are statements that suggest the possibility of mechanical damage as a result of an action.

For example:

CAUTION: Do not connect the network cable to the machine until instructed to do so.

Notes

Notes are statements that provide additional information.

For example:

NOTE: It is recommended that you change the password from the default one. For further assistance, contact your Xerox Welcome Center.

Related Information Sources

The following additional sources of information are available for the machine.

- Xerox CopyCentre/WorkCentre 118 Quick Reference Guide
- Xerox CopyCentre/WorkCentre 118 User Guide
- The On-line Help system (Print Drivers and CentreWare Utilities)
- The CentreWare Utilities Documentation (HTML)

NOTE: The screens shown in this guide apply to a fully configured machine, so they may not exactly represent the configuration in use.

2 Product Overview

This chapter gives an overview of the features and functions of the machine and enables familiarity with the device network installation.

Detailed information is provided through the following sections.

Identifying the Machine Components – page 13

Power On/Off – page 14

Cabling – page 15

Modes – page 16

System Controls – page 25

System Settings – page 26

Resident Fonts – page 28

Identifying the Machine Components

This machine is a digital device capable of being used for copying, faxing, printing and scanning. The following diagram shows the standard components of the machine. There are also a number of optional components available. For more information about the optional components, refer to the Product Overview chapter of the User Guide, or contact your Xerox Sales Representative.

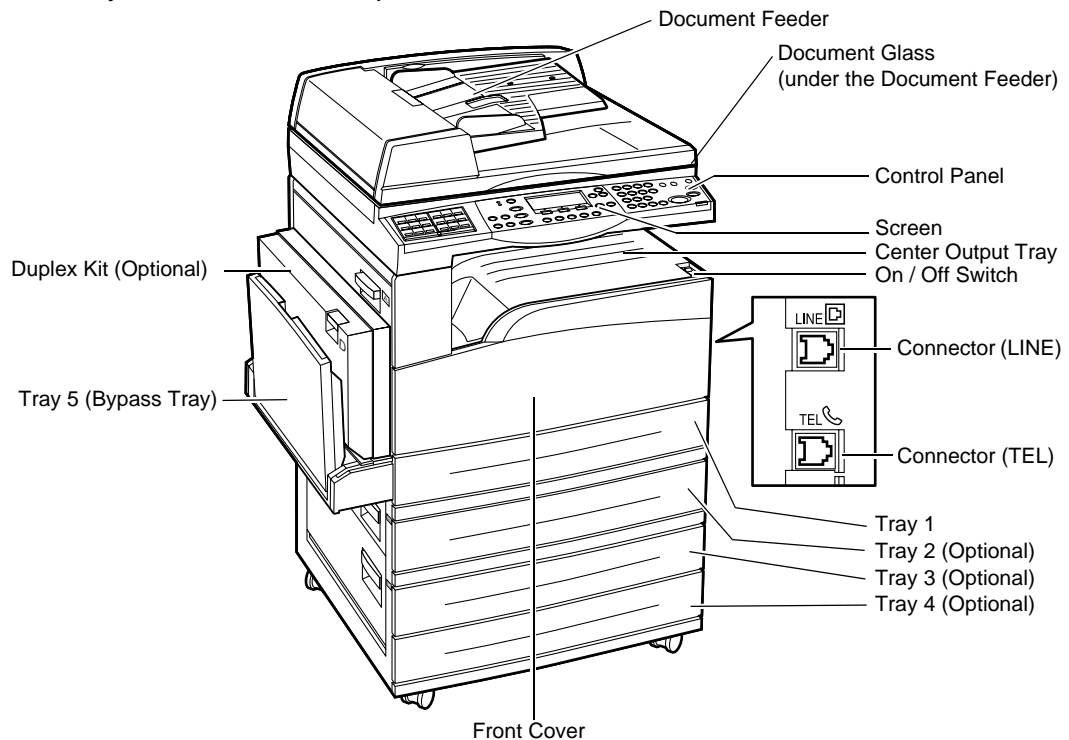

NOTE: Depending on the configuration, the Document Glass Cover is attached instead of the Document Feeder. A maximum of three optional paper trays can be attached.

Power On/Off

Powering On

Make sure that the machine is connected to a suitable power supply and that the power plug is firmly connected to the electrical outlet. For more information, refer to the Specifications chapter of the User Guide.

The machine is ready to make copies about 25 seconds after the power is switched on.

1. Press the power switch to the <I> position.

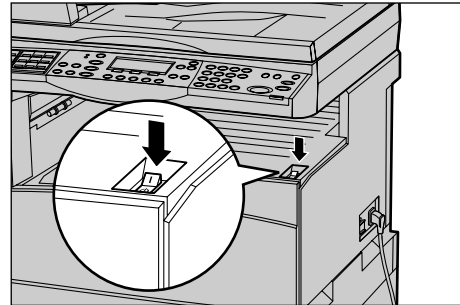

NOTE: If the machine does not start up, check that the <RESET> button on the side of the machine is in the reset position.



Powering Off

If the Fax option is installed, make sure that the <Jobs in Memory> indicator on the control panel is off before you switch off the machine. If you switch off the machine while the <Jobs in Memory> indicator is lit for more than hour, all stored documents will be deleted. After charging for 30 hours, the machine is able to keep stored documents for an hour.

NOTE: Wait at least 20 seconds between powering the system on and off. Failure to do this could cause damage to the disk.

Cabling

Interface Ports

The machine has multiple interface ports as shown in the following diagram.

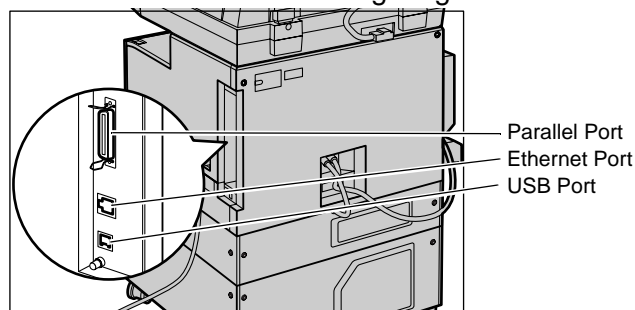

Ethernet 10BASE-T/100BASE-TX

The machine is compatible with SMB, LPD, EtherTalk, NetWare, IPP, HTTP, DHCP, SMTP, POP, DDNS, RARP, and Port 9100. It supports T connector as a standard feature.

There are three Ethernet interface options available on the screen: 10BASE-T, 100BASE-TX and AUTO. 10BASE-T and 100BASE-TX support 10 Mbps and 100 Mbps respectively. When AUTO is selected, the machine detects the communication speed automatically when powered on and adjusts its setting accordingly.

EtherTalk, NetWare, and TCP/IP protocols that use Ethernet can be switched automatically according to the applied transmission protocol.

NOTE: EtherTalk will function when the optional PostScript Kit is installed.

Parallel (IEEE1284) Host Connection

One parallel interface is provided for the print use as standard on the machine, which enables direct connection to the host computer.

This high-speed Centronics port, conforming to IEEE1284, allows two-way communication between a computer and the machine. Use a full-pitch connector.

IEEE1284 (that supports nibble and ECP) is supplied for the print use on the standard configuration. For data input via Centronics, Adobe Communication Protocol is supported. Adobe Communication Protocol is compatible with four modes: Raw, Standard, Binary, TBCP.

NOTE: Adobe Communication Protocol can be set when the PostScript Kit (optional) has been installed.

USB 2.0(Universal Serial Bus)

USB 2.0 is supported for the print use on the standard configuration and is used as an input port for printing data. This is compatible with Full Speed (12 Mbps), and High Speed (480 Mbps), but not applied to Low Speed (1.5 Mbps).

Modes

The mode buttons are used to access the screens which allow you to select features, monitor the status of jobs and obtain general information about the machine.

There are six mode buttons on the machine:

- Copy
- Fax
- E-Mail
- Log In/Out
- Job Status
- Machine Status

NOTE: Depending on the configuration, there may be three mode buttons, the <Log In/Out>, <Job Status> and <Machine Status> buttons, on the machine.

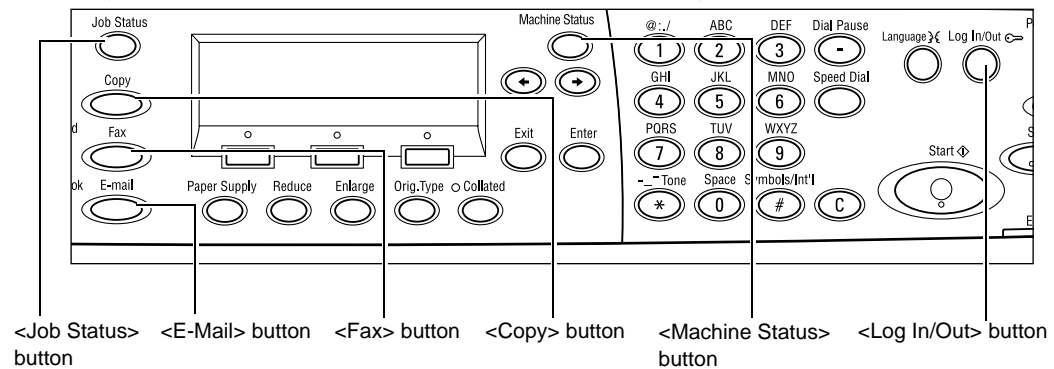

Copy

Use this button to access the Copy function which is used to make copies. The Copy mode contains three screens which provide access to the many Copy features.

Features such as Reduce/Enlarge, Multiple-Up and Mixed Size Originals are available to support all of your copying requirements.

1. Press the <Copy> button on the control panel.
2. Press the <←> or <→> button to switch between screens.
3. To exit the Copy mode, press another mode button.

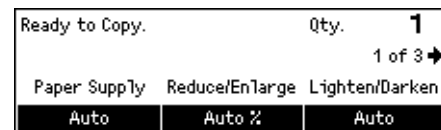

For more information about Copy features, refer to the Copy chapter of the User Guide.

Fax

Use this button to access the optional Fax function which is used to send faxes and access functions such as Mailbox and Polling. The Fax mode contains seven screens used to access features such as Resolution, Delayed Start and Priority Send.

1. Press the <Fax> button on the control panel.
2. Press the <←> or <→> button to switch between screens.
3. To exit the Fax mode, press another mode button.



For more information about Fax features, refer to the Fax chapter of the User Guide.

E-mail

Use this button to access the optional E-mail function used for sending e-mails. The E-mail mode contains three screens which provide access to the E-mail features.

Features such as Lighten/Darken, Scan Size and 2 Sided Originals are available to support all of your e-mail requirements.

1. Press the <E-mail> button on the control panel.
2. Press the <←> or <→> button to switch between screens.
3. To exit the E-mail mode, press another mode button.

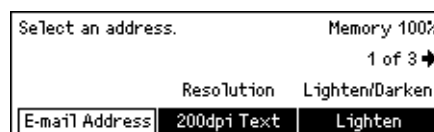

For more information about E-mail features, refer to the E-mail chapter of the User Guide.

Log In/Out

Use this button to log in to the machine as the Key Operator. You can change the various default settings and register a destination in the Address book, a Fax Program, a Mailbox, or a Bulletin Board.

When the Auditron feature is enabled, enter the password you need to use the account on the screen displayed after pressing the <Log In/Out> button.

1. Press the <Log In/Out> button on the control panel.
2. Select the required option.



NOTE: To select System Settings, the Key Operator password is required. The default Key Operator password is "11111".

For more information, refer to Setup Procedures in the Setups chapter of the User Guide.

Job Status

Use this button to view the progress of a job and if necessary, stop and delete the job. It can also display the log and detailed information about completed jobs. The latest job will be at the top of the list.

1. Press the <Job Status> button on the control panel.
2. Press the <←> or <→> button to switch between screens.
3. Press the <Job Status> button at any time to exit.

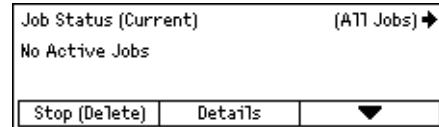

For more information, refer to the following.

Current – page 18

All Jobs – page 18

Current

Displays the jobs in progress. You can view the job attributes or delete jobs from this screen. Use the <Select> button on the control panel to select a job. If there is no job in progress, the following message displays: “No Active Jobs”.

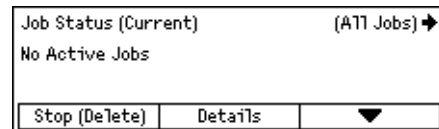

Stop (Delete)

Stops the job in progress and deletes it from the queue.

Details

Displays the job attributes. The contents of each screen may differ depending on the type or status of the job.

All Jobs

Displays the jobs waiting or suspended, and all finished jobs in the system.

The contents of each screen may differ depending on the type or status of the job.

1. Press the <→> button on the control panel.
2. Select the required option.

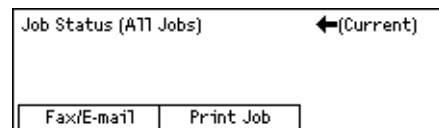

Fax/E-mail

You can select either [Send] or [Receive] for a fax job, and [Send] for an e-mail job.

- Send – Displays the fax and e-mail out-going jobs. Select a job from the list using the <Select> buttons and select [Details] to view the job attributes on the next screen.

- Receive – Displays the fax in-coming jobs. Select a job from the list using the <Select> buttons and select [Details] to view the job attributes on the next screen.

Print Job

Displays the print jobs. The suspended and completed jobs are not displayed. Select a job from the list using the <Select> buttons and select [Details] to view the job attributes on the next screen.

- Details – Displays the job attributes. You can cancel or eject the job from each screen using the [Cancel] or [Eject] options.



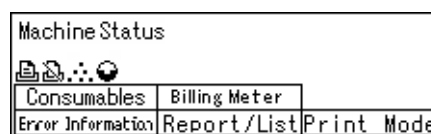

Machine Status

Use this button to display information about the machine. This button allows you to view the billing meter, print lists/reports, check the paper supply, and review the status of faults.

1. Press the <Machine Status> button on the control panel.
Press the <Machine Status> button at any time to exit.



The following icons show the status of print job or consumables.

-  – Shows the print job in progress.
-  – Shows the error in the print jobs.
-  – Shows the toner cartridge needs to be replaced soon.
-  – Shows the drum cartridge needs to be replaced soon.

For more information, refer to the following.

Error Information – page 19

Consumables – page 20

Report/List (Non-print Jobs) – page 20

Report/List (Print Jobs) – page 21

Billing Meter – page 22

Print Mode – page 23

Error Information

This screen allows you to view the date and time of the errors, the error codes and the status of each error.

The contents of each screen may differ depending on the type or status of the job.

1. Select [Error Information] on the [Machine Status] screen using the <Select> button.

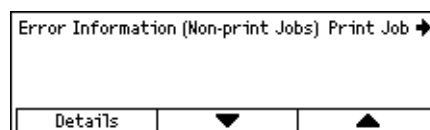

2. Press the <Enter> button.
3. Press the <<-> or <->> button to switch between screens.

Non-print

Displays the error information for all jobs except print jobs. Select a job from the list using the <Select> buttons and select [Details] to view the job attributes on the next screen.

Print Job

Displays the error information of print jobs. Select a job from the list using the <Select> buttons and select [Details] to view the job attributes on the next screen.

Consumables

This screen allows you to check the status of cartridges.

1. Select [Consumables] on the [Machine Status] screen using the <Select> button.
2. Press the <Enter> button.

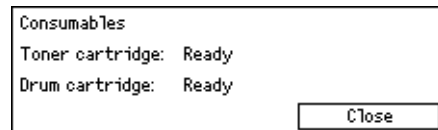

Toner Cartridge

Displays the remains of the toner cartridge with three levels.

Drum Cartridge

Displays the remains of the drum cartridge with three levels.

Report/List (Non-print Jobs)

This screen allows you to print various reports and lists for each non-print jobs.

1. Select [Report/List] on the [Machine Status] screen using the <Select> button.
2. Press the <Enter> button.
3. Select the required option.
4. To print the selected report or list, press the <Enter> button, and then press the <Start> button.

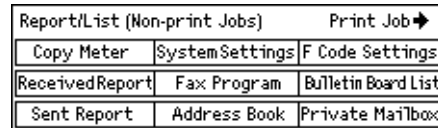

Sent Report

Prints a Sent Report which provides information about the last 50 fax transmissions and e-mail sendings. The detailed information reported for each job includes: the recipient name, the transmission time, the modes, and the transmission result.

Received Report

Prints a Received Report which provides information about the last 50 faxes received. The detailed information reported for each job includes: the sender name, the reception time, the modes, and the result.

Copy Meter

Confirm the account data, such as the account name, the limit set for the account, and the total number of copies, for each account.

Address Book

Confirm the contents of Address Book. The contents are printed as a list with recipient names, fax numbers and F Code for fax, e-mail addresses for e-mail in numerical order of Speed Dial code.

Fax Program

Prints detailed information for each Fax Program. The list includes the program name, the setting for each feature, the recipient name, and the Speed Dial code.

System Settings

Confirm the status of settings on this machine. Prints out contents of serial number, Auditoron details, and Copy/Fax/e-mail settings as a report of a list.

Mailbox

Confirm a list of registered mailboxes. Prints out the box names and F Code, etc in numerical order of box number.

Bulletin Board List

Prints out a report as a list of registered bulletin boards. The list shows titles of registered documents, date and time of document registration, etc., in numerical order of bulletin board.

F Code Settings

Prints a report detailing information about the F Code receive settings for the mailboxes registered. The list includes reception information such as the F Code or password, or information about the forwarding destination.

Report/List (Print Jobs)

This screen allows you to print various reports and lists for print jobs.

1. Select [Report/List] on the [Machine Status] screen using the <Select> button.
2. Press the <Enter> button.
3. Press the <=> button to display the Print Jobs screen.
4. Select the required option by selecting [▼] or [▲] using the <Select> button.
5. To print out the selected report or list, press the <Enter> button, and then press the <Start> button.

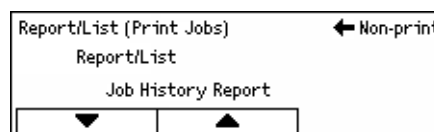

Job History Report

Prints information on printing results, such as whether data from the PC has been printed correctly. The status of a maximum of 50 jobs can be printed on the report.

Description of jobs with errors are printed in the [Job Status] column. For details on the error description, refer to Fault Codes in the Problem Solving Chapter of the User Guide.

Error History Report

Prints information of up to the latest 50 errors that occurred in the machine. For Error code, refer to Fault Code in the Problem Solving chapter of the User Guide.

Print Meter

Prints information on the total printed pages and total number of sheets used in the machine according to different PC or job owners. The [Print Meter Report] counts pages from the point where data has been initialized.

System Settings

Prints status of the machine such as hardware configuration and network information. Print this report to check whether optional accessories have been correctly installed.

Fonts List

Prints a list of the resident fonts that can be used on the machine.

PS Fonts List

Prints a list of PostScript fonts that can be used on the machine when the PostScript Kit is installed.

Print Language

Allows you to print a report or a list of the following print language information.

Press the <Enter> button, and then select the required option by selecting [▼] or [▲] using the <Select> button.

- PCL Form List – Prints a list of the registered PCL form.
- PS Logical – Prints a list of printers created in PostScript when the PostScript kit has been installed. Allows you to check the settings for up to 10 registered logical printers.
- PDF Settings – Prints a report which provides the various settings in the PDF print mode.
- PCL Settings – Prints a report which provides the various settings in the PCL print mode.

Billing Meter

Allows you to view the total number of prints made on the machine. You can also view the machine Serial Number.

1. Select [Billing Meter] on the [Machine Status] screen using the <Select> button.
2. Press the <Enter> button.

Serial No.	XXXXXXXXXX
Total:	9999999
Print Jobs:	9999999
Non-print Jobs:	9999999

Serial No.

Displays the Serial Number of the machine.

Total

Indicates the total number of prints made on the machine.

Print Jobs

Indicates the total number of pages used for print jobs.

Non-print Jobs

Indicates the total number of pages used for all jobs except print jobs.

Print Mode

Allows you to change the default printer mode and change printer language settings.

1. Select [Print Mode] on the [Machine Status] screen using the <Select> button.
2. Press the <Enter> button.

Print Jobs	
Off-Line	Emulation
On-Line	

On-line

Sets the printer mode to online.

Off-line

Sets the printer mode to offline. When offline, the machine cannot receive data or process printing.

Emulation

Sets the Emulation mode of PDF or PCL.

To set the details, select [Emulation] using the <Select> button and press the <Enter> button. Then, select the required option by selecting [▼] or [▲] using the <Select> button.

PDF

- Quantity – Specify the copies to be printed between 1 to 999.
- 2 Sided Print - Specify whether or not to do double-sided printing. When double-sided printing is enabled, select which edge of the paper is to be bound: [Flip on long edge] or [Flip on short edge].
- Print Mode – Select the print mode from [Normal], [High Quality], or [High Speed].

- Password – If a password has been set for a PDF file, specify the password here in advance. Printing will be performed only when the password set in the PDF file to be printed matches the password specified here.
- Collated – Select this to set whether to collate multiple copies of the printout by sets (sorted in the order of page 1, 2, 3,... 1, 2, 3...).
- Paper Size – Select the paper size from [A4] or [Auto].
Select [Auto] to print on a paper size that is automatically determined according to the size and settings of the PDF file to be printed.

PCL

- Paper Tray – Select the paper tray to be used for printing.
- Paper Size – Select the paper size to be printed.
- Bypass Size – Select the paper size for Tray 5 (bypass tray).
- Orientation – Select the print orientation: [Portrait] or [Landscape].
- 2 Sided Print – Specify whether or not to do double-sided printing. When [On] is selected, select which edge of paper is to be bound:[Flip on long edge] or [Flip on short edge].
- Font – Specify the font used.
- Symbol Set – Specify the font symbols.
- Font Size – Specify the font size. You can specify a value between 4.00 and 50.00 in increments of 0.25.
- Font Pitch – Specify the character spacing. You can specify a value between 6.00 and 24.00 in increments of 0.01.
- Form Lines – Specify the form line (the number of lines per form). You can specify a value between 5 and 128 in increments of 1.
- Quantity – Specify the copies to be printed between 1 to 999.
- Image Enhancement – Select whether to perform image enhancement. Image enhancement is a feature that makes the boundary line between black and white smoother to decrease jags and enhance the visual appearance.
- HexDump – Specify whether to print the data sent from a PC in the ASCII code corresponding to the hexadecimal notation format in order to check the data contents.
- Draft Mode – Specify whether or not to print in draft mode.
- Line Termination – Select the line termination from [Off], [Add-LF] (appends a line feed to carriage return, [Add-CR] (appends a carriage return to line feed and form feed), or [CR-XX] (appends a carriage return to line feed and form feed, and a line feed to carriage return)

System Controls

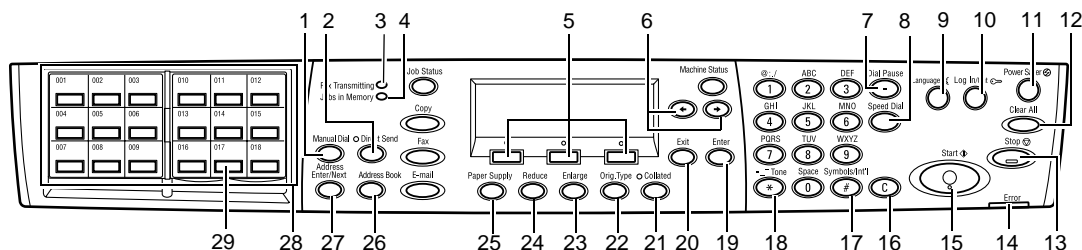

	Button/Indicator	Function
1	<Manual Dial>	Allows you to send and receive documents manually. This button works only for faxing with the document feeder; When the document is loaded into the feeder, you can press the button only for sending. When the document is not loaded into the feeder, you can press the button only for receiving.
2	<Direct Send>	Allows you to use the direct send feature. Refer to Direct Send in the Fax chapter of the User Guide.
3	<Fax Transmitting>	Indicates that data is being transmitted or received.
4	<Jobs in Memory>	Indicates there is data stored in the machine.
5	<Select>	Allows you to select options displayed on the screen. Each press of the <Select> button moves you up one option.
6	<←><→>	Use these buttons to switch between screens. You can also use them to move the cursor in the entry field.
7	<Dial Pause>	Enters a pause in a telephone number when transmitting a fax.
8	<Speed Dial>	Allows you to specify the fax number or e-mail address using Speed Dial codes.
9	<Language>	Changes the language displayed on the screen.
10	<Log In/Out>	Allows you to log in to the machine as the Key Operator, and change the default settings. You can also register a destination in the Address Book, a Fax Program, or a bulletin board. Refer to Setups chapter of the User Guide.
11	<Power Saver> (Green light)	Indicates whether the machine is in the power saver mode. Also allows you to cancel this mode.
12	<Clear All>	Restores the default settings and resume to the first screen of Copy or Fax.
13	<Stop>	Temporarily stops a job.

	Button/Indicator	Function
14	<Error>	Indicates that an error occurred.
15	<Start>	Starts or resume a job.
16	<C>	Deletes a numeric value or the last letter and symbol entered. Also cancels the job.
17	<# (hash)>	Indicates the symbols.
18	<*(asterisk)>	Used when you switch the machine to tone.
19	<Enter>	Determines any changed settings or entered values.
20	<Exit>	Returns to the previous screen without acquiring any changed settings or entered values.
21	<Collated>	Provides a quick way of using the sort feature.
22	<Orig. Type>	Provides a quick way of selecting the document type.
23	<Enlarge>	Provides a quick way of specifying the enlarge ratio.
24	<Reduce>	Provides a quick way of specifying the reduction ratio.
25	<Paper Supply>	Provides a quick way of selecting the paper tray.
26	<Address Book>	Allows you to select the destination registered in the Address Book or the program registered in the Fax Program.
27	<Address Enter/Next>	Allows you to send a fax or e-mail to the multiple destinations at the same time.
28	One Touch panels	Displays the number of One Touch buttons. Flip the panel to access the page 1 (001 to 018), page 2 (019 to 036), or page 3 (p01 to p18 for Fax Program).
29	One Touch buttons	Specifies Speed Dial or the Fax Program at a single touch.

System Settings

During manufacture the machine is pre-programmed with default settings which can be customized using the System Settings. The System Settings can be accessed via the <Log In/Out> button. The following set up categories are available.

- Change Password
- Common Settings
- Audition Administration
- Copy Settings
- Print Settings

- Fax Settings
- E-mail Settings

NOTE: CentreWare Internet Services is software that enables you to display, configure and change the settings of the machine by using a browser on a computer instead of the machine's control panel. For more information, refer to the CentreWare Internet Service chapter of the User Guide.

Changing the Settings

Password input is required to change the settings. The machine is delivered with the factory default password "11111". It allows you to access the System Settings described in this chapter.

NOTE: You are advised to change the default password to a more secure one. For further assistance, refer to Change Password in the Setups Chapter of the User Guide or contact your Xerox Welcome Center.

Follow these steps to change the default settings:

1. Press the <Log In/Out> button on the control panel.

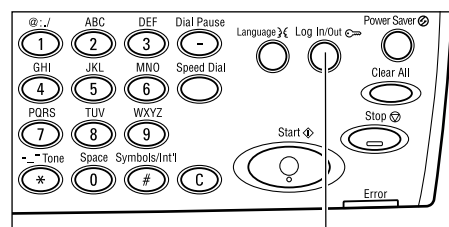

<Log In/Out> button

2. Select [System Settings] using the <Select> button.
3. Enter the Key Operator password using the numeric keypad on the control panel.
4. Select [Confirm] using <Select> button, or press the <Enter> button.
5. Select [Common Settings] on the [System Settings] screen using the <Select> button.
6. Press the <Enter> button.
7. Select the required option and customize to meet your needs.
8. Press the <Enter> button.

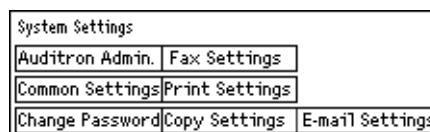
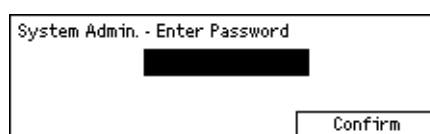
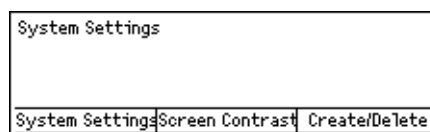

NOTE: The appearance of the screen on your machine may differ slightly depending on the model and configuration. However, feature descriptions and functionality described here remain the same.

Ethernet Port

The Ethernet port is the default interface used on the machine.

If you need to change the speed setting of the Ethernet port, perform the following steps:

1. Select [Print Settings] on the [System Settings] screen, and press the <Enter> button.
2. Press the <Enter> button on the [Network/Port] screen.
3. Select [Ethernet Settings] by selecting [▼] or [▲] using the <Select> button.
4. Press the <Enter> button.
5. Select port speed by selecting [▼] or [▲] using the <Select> button.
6. Press the <Enter> button.

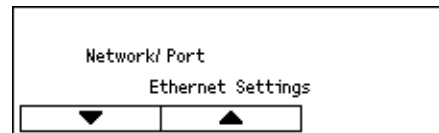
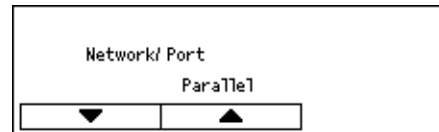
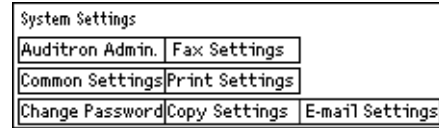

Auto

Detects transmission speed automatically at power on and adjusts itself accordingly.

100BASE-TX

Sets the transmission speed to 100 Mbps.

10BASE-T

Sets the network speed to 10 Mbps.

Resident Fonts

PCL Resident Fonts

One of the fonts in the following table can be selected as the default font for the machine. Other bitmap and scalable fonts can be downloaded with print jobs sent to the machine using printer drivers. The default is used when a font is not defined in the PCL job stream. The PCL versions used are PCL5e and PCL6.

You can view the PCL fonts by printing the Fonts List. For more information on how to print the list, refer to Product Overview chapter of the User Guide.

Value	Description	Value	Description
0	CG Times	41	Times New Bold
1	CG Times Italic	42	Times New Bold Italic
2	CG Times Bold	43	Symbol
3	CG Times Bold Italic	44	Wingdings
4	Univers Medium	45	Line Printer
5	Univers Medium Italic	46	Times Roman
6	Univers Bold	47	Times Italic
7	Univers Bold Italic	48	Times Bold
8	Univers Medium Condensed	49	Times Bold Italic
9	Univers Medium Condensed Italic	50	Helvetica
10	Univers Bold Condensed	51	Helvetica Oblique
11	Univers Bold Condensed Italic	52	Helvetica Bold
12	Antique Olive	53	Helvetica Bold Oblique
13	Antique Olive Italic	54	CourierPS
14	Antique Olive Bold	55	CourierPS Oblique
15	CG Omega	56	CourierPS Bold
16	CG Omega Italic	57	CourierPS Bold Oblique
17	CG Omega Bold	58	SymbolPS
18	CG Omega Bold Italic	59	Palatino Roman
19	Garamond Antiqua	60	Palatino Italic
20	Garamond Kursiv	61	Palatino Bold
21	Garamond Halbfett	62	Palatino Bold Italic
22	Garamond Kursiv Halbfett	63	ITC Bookman Light
23	Courier (default)	64	ITC Bookman Light Italic
24	Courier Italic	65	ITC Bookman Demi
25	Courier Bold	66	ITC Bookman Demi Italic
26	Courier Bold Italic	67	Helvetica Nscroll
27	Letter Gothic	68	Helvetica Nscroll Oblique
28	Letter Gothic Italic	69	Helvetica Nscroll Bold
29	Letter Gothic Bold	70	Helvetica Nscroll Bold Oblique
30	Albertus Medium	71	New Century Schoolbook Roman

Value	Description	Value	Description
31	Albertus Extra Bold	72	New Century Schoolbook Italic
32	Clarendon Condensed	73	New Century Schoolbook Bold
33	Coronet	74	New Century Schoolbook Bold Italic
34	Marigold	75	ITC Avant Garde Book
35	Arial	76	ITC Avant Garde Book Oblique
36	Arial Italic	77	ITC Avant Garde Demi
37	Arial Bold	78	ITC Avant Garde Demi Oblique
38	Arial Bold Italic	79	ITC Zapf Chancery Medium Italic
39	Times New	80	ITC Zapf Dingbats
40	Times New Italic		

Symbol Set

One of the following symbol sets can be selected as the default symbol set. The default symbol set is used when a symbol set is not defined in the PCL job stream.

Code	Value	Short Display	Long Display
8U	277	ROMAN-8	Roman 8 (default)
0N	14	ISO L1	ISO 8859-1 Latin 1
2N	78	ISO L2	ISO 8859-2 Latin 2
5N	174	ISO L5	ISO 8859-9 Latin 5
6N	206	ISO L6	ISO 8859-10 Latin 6
10U	341	PC-8	PC-8
11U	373	PC-8 DN	PC-8 DN
26U	853	PC-775	PC-775
12U	405	PC-850	PC-850
17U	565	PC-852	PC-852
9J	298	PC-1004	PC-1004 (OS/2)
9T	308	PC-8 TK	PC Turkish
19U	629	WIN L1	Windows 3.1 Latin 1
9E	293	WIN L2	Windows 3.1 Latin 2
5T	180	WIN L5	Windows 3.1 Latin 5

Code	Value	Short Display	Long Display
7J	234	DESKTOP	DeskTop
10J	330	PS TEXT	PS Text
12J	394	MC TEXT	MC Text
6J	202	MS PUB	Microsoft Publishing
8M	269	MATH-8	Math 8
5M	173	PS MATH	PS Math
15U	501	PI FONT	Pi Font
1U	53	LEGAL	Legal
1E	37	ISO-4	ISO 4 United Kingdom
0U	21	ISO-6	ISO 6 ASCII
0S	19	ISO-11	ISO 11 Swedish:names
0I	9	ISO-15	ISO 15 Italian
2S	83	ISO-17	ISO 17 Spanish
1G	39	ISO-21	ISO 21 German
0D	4	ISO-60	ISO 60 Norwegian v1
1F	38	ISO-69	ISO 69 French
9U	309	WIN 3.0	Windows 3.0 Latin 1
19L	620	WINBALT	Windows Baltic
19M	621	SYMBOL	Symbol
579L	18540	WINGDINGS	Wingdings

3 NetWare

This chapter explains how to install the machine onto a NetWare network. The following information is provided.

Information Checklist – page 33

NetWare Environments – page 34

NetWare Installation – page 35

Installation Procedure – page 35

Network Communication Setup – page 35

NetWare Setup – page 37

Workstation Setup – page 37

Test Print – page 37

Information Checklist

Before installing the machine onto a network, make sure that the following items are available or have been performed.

Item	By
An existing operational NetWare network is required. These procedures are not designed to install a NetWare network.	Customer
NetWare versions 3.x, 4.x, 5.x or 6.x.	Customer
Obtain and record the following information, if required: <ul style="list-style-type: none">• IP address• Gateway address• Subnet mask• Host name Refer to the glossary for additional information about the Gateway Address and Subnet mask, if needed.	Customer
Test the machine to make sure that it is installed fully and functioning correctly.	Customer
Print driver for the machine	Customer

If problems arise during the machine installation, refer to *Problem Solving chapter* for assistance.

CAUTION: Do not connect the network cable to the machine until instructed to do so.

NetWare Environments

System configuration

The machine supports NetWare PServer mode in Bindery or NDS. NetWare 3.x/4.x/5.x/6.x is required to support Bindery. NetWare 4.11 or later is required to support NDS. In the PServer mode, the machine will function as a print server and print jobs from the print queue. The machine uses one file server user license.

NOTE: The machine does not support RPrinter mode.

Target computers

The NetWare versions and NetWare client computers require the following environments.

NetWare versions

A Novell-accredited computer which can be installed with NetWare 3.x/4.x/5.x/6.x.

NetWare client computers

A Novell-accredited computer which can run Windows 95, Windows 98, Windows NT 4.0 or Windows 2000.

NOTE: When using the LPD port by Novell Distributed Print Services (NDPS), activate the LPD port on the machine and set the IP address.

IPX/SPX frame types

The machine supports the following Ethernet interfaces.

- 10Base-T (Twisted Pair Cable)
- 100Base-TX (Twisted Pair Cable)

The machine supports the following frame types:

- Ethernet II specification
- IEEE802.3 specification
- IEEE802.3/802.2 specification
- IEEE802.3/802.2/SNAP specification

The machine will send out packets of each frame type on the connected network. It will automatically use the frame type which corresponds to the first response. However, if more than one protocol is running simultaneously on the same network, the machine will use the same frame type as used by the NetWare server.

NOTE: Some network components, such as the hub may not support automatic frame type setup. If the data link indicator light of the port does not light up, match the IPX/SPX setting of the frame type of the machine, to the frame type of the file server.

NetWare Installation

This section describes the installation procedures to use the machine in a NetWare environment.

Installation Procedure

The installation procedure is as follows.

Network Communication Setup

For more information, refer to *Network Communication Setup on page 35*.

NetWare Setup

For more information, refer to *NetWare Setup on page 37*.

Workstation Setup

For more information, refer to *Workstation Setup on page 37*.

Test Print

For more information, refer to *Test Print on page 37*.

Network Communication Setup

Use this procedure to set up the network communication parameters of the machine.

At the machine, perform these steps.

NOTE: Keep the SNMP port enabled while you use the machine on the TCP/IP network.

NOTE: CentreWare Internet Services can also be used to configure the machine. Refer to *CentreWare Internet Services chapter on page 91*.

First, enable the NetWare port.

1. Connect the machine to the network.
2. Press the <Log In/Out> button.
3. Select [System Settings].
4. Enter the password using the numeric keypad and then select [Confirm].
5. Select [Print Settings] and then press the <Enter> button.
6. Press the <Enter> button on the [Network/Port] screen.
7. Select [NetWare] by selecting [▼] or [▲] and then press the <Enter> button.
8. Select [Port Status] by selecting [▼] or [▲] and then press the <Enter> button.
9. Select [Enable] by selecting [▼] or [▲] and then press the <Enter> button.

If necessary, you may change the following settings.

- Transport Protocol
- Print Mode
- PJL
- Number of searches

Next, establish TCP/IP if you use an IP address for a NetWare network.

If IP address setting is unnecessary, press the <Login/Out> button to go to *NetWare Setup on page 37*.

1. Press the <Exit> button once or twice to display the [Network/Port] screen.
2. Select [TCP/IP Settings] by selecting [▼] or [▲] and then press the <Enter> button.
3. Select [Get IP Address] by selecting [▼] or [▲] and then press the <Enter> button.
4. Select [DHCP/Autonet], [DHCP], [BOOTP], [RARP], or [Manual] by selecting [▼] or [▲] and then press the <Enter> button.

NOTE: Use the DHCP server together with the Windows Internet Name Service (WINS) server.

If you selected [Manual] in step 4, use the following steps to enter the IP address.

If you selected other than [Manual], press the <Login/Out> button and then go to *Workstation Setup on page 37*.

1. Press the <Exit> button.
2. Select [IP Address] by selecting [▼] or [▲] and then press the <Enter> button.
3. Use the numeric keypad to enter the IP address in the format "xxx.xxx.xxx.xxx".

NOTE: Press the <→> button to move to the next section. Press the <←> button to return to the previous section.

NOTE: You cannot enter 127, 254, or 255 into the first section of the format.

4. Press the <Enter> button.
5. Press the <Exit> button.
6. Use the same steps as IP address setting to enter the subnet mask and gateway address.

NOTE: You can enter 000, 128, 192, 224, 240, 248, 252, 254, or 255 into each section as the values for the subnet mask.

NOTE: You cannot enter 127, 254, or 255 into the first section of the format for the gateway address.

7. Press the <Log In/Out> button.

NOTE: If you wish to filter access to the machine from the client computers, activate the IP Filter. The [Filter] screen is located in the same layer as the [TCP/IP Settings] screen.

NetWare Setup

Use PCONSOLE or NetWare Administrator (NWADMIN) to create a print queue, print server and printer, and assign the respective objects. For information on how to use PCONSOLE or NWADMIN, refer to the manual which comes with NetWare.

When using in the PSERVER mode, set as follows.

- Printer server name - use the same device name as the target printer.
- Printer location - set as Auto Load.
- Printer Type - set as Parallel
- Parallel Setting - set as Auto

For NetWare 5, only NWADMIN is available for use.

Workstation Setup

Install the print driver on the NetWare client computer. Refer to the HTML documentation in CentreWare Utilities CD-ROM.

Test Print

To make sure that the machine has been installed on the network correctly, submit a test print from a client workstation. Perform the following steps.

1. Open a document on a client workstation.
2. Select the machine as the printer.
3. Print the document on the machine and verify that it prints correctly.
4. Make sure that the print driver is installed on every workstation that will be sending jobs to the machine.
5. Repeat the test for all workstations that will be sending jobs to the machine.

The installation process is now complete.

If the test print fails, refer to *Problem Solving chapter* for assistance.

4 UNIX TCP/IP

This chapter explains how to set up the machine to operate in a UNIX TCP/IP environment. The UNIX Workstation Operating Systems (OS) supported are Solaris, SunOS, and HP-UX. The following information is provided.

- Information Checklist – page 39*
- UNIX TCP/IP Environments – page 40*
- UNIX TCP/IP Installation – page 40*
- Installation Procedure – page 40*
- Network Communication Setup – page 41*
- Workstation Setup – page 42*
- Test Print – page 47*
- Printing – page 48*
- Solaris/HP-UX – page 48*
- SunOS – page 50*
- Printer Status – page 52*
- Solaris/HP-UX – page 52*
- SunOS – page 53*
- C Option – page 54*

Information Checklist

Before installing the UNIX TCP/IP features on the machine, make sure that the following items are available or have been performed.

Item	By
An existing operational network utilizing a UNIX TCP/IP protocol is required. These steps are not designed to install the UNIX TCP/IP network.	Customer
SunOS 4.1.x, Solaris 1.x, 2.x, 7.x, 8.x, 9.x, HP-UX 9.x, 10.x or 11.x	Customer
Make sure that the correct IP Address is being used for the machine.	Customer
Make sure that the Gateway Address is set correctly.	Customer
Make sure that the Subnet Mask is set correctly.	Customer
Make sure that the Host Name is set correctly.	Customer
Test the copy and fax features of the machine, to make sure that they are installed fully and functioning correctly.	Customer

If you encounter problems during the installation of the machine, refer to *Problem Solving chapter* for assistance.

CAUTION: Do not connect the network cable to the machine until instructed to do so.

UNIX TCP/IP Environments

System configuration

The machine uses the Line Printer Daemon Protocol (LPD) that supports TCP/IP as the transport protocol. With the LPD, use the machine as a UNIX network printer.

The LPD supports spool mode, this is where print jobs from clients are spooled once before output. It also supports non-spool mode, this is where print jobs are output sequentially, without spooling.

Target computers

The target computers are as follows.

- Workstation or personal computer with RFC 1179 Line Printer Daemon Protocol

Interface

The LPD is available on the following interfaces:

- Ethernet 100Base-TX
- Ethernet 10Base-T

The applicable frame types conform to Ethernet II (Ethernet interface).

UNIX TCP/IP Installation

This section explains how to install the machine in a UNIX TCP/IP environment.

Installation Procedure

There are three stages.

Network Communication Setup

This requires the machine to be set up and configured for TCP/IP.

Workstation Setup

This requires the appropriate workstation OS to be configured for the machine.

Test Print

A print job should be submitted to make sure that the machine has been installed and configured correctly.

Network Communication Setup

Use this procedure to set up the network communication parameters of the machine.

NOTE: Keep the SNMP port enabled while you use the machine on the TCP/IP network.

NOTE: CentreWare Internet Services can also be used to configure the machine. Refer to *CentreWare Internet Services chapter on page 91*.

Follow the steps below to establish TCP/IP.

1. Connect the machine to the network.
2. Press the <Log In/Out> button.
3. Select [System Settings].
4. Enter the password using the numeric keypad and then select [Confirm].
5. Select [Print Settings] and then press the <Enter> button.
6. Press the <Enter> button on the [Network/Port] screen.
7. Select [TCP/IP Settings] by selecting [▼] or [▲] and then press the <Enter> button.
8. Select [Get IP Address] by selecting [▼] or [▲] and then press the <Enter> button.
9. Select [DHCP/Autonet], [DHCP], [BOOTP], [RARP], or [Manual] by selecting [▼] or [▲] and then press the <Enter> button.

NOTE: Use the DHCP server together with the Windows Internet Name Service (WINS) server.

If you selected [Manual] in step 9, use the following steps to enter the IP address.

If you selected other than [Manual], press the <Login/Out> button and then go to *Workstation Setup on page 42*.

1. Press the <Exit> button.
2. Select [IP Address] by selecting [▼] or [▲] and then press the <Enter> button.
3. Use the numeric keypad to enter the IP address in the format "xxx.xxx.xxx.xxx".

NOTE: Press the <→> button to move to the next section. Press the <←> button to return to the previous section.

NOTE: You cannot enter 127, 254, or 255 into the first section of the format.

4. Press the <Enter> button.
5. Press the <Exit> button.

6. Use the same steps as IP address setting to enter the subnet mask and gateway address.

NOTE: You can enter 000, 128, 192, 224, 240, 248, 252, 254, or 255 into each section as the values for the subnet mask.

NOTE: You cannot enter 127, 254, or 255 into the first section of the format for the gateway address.

7. Press the <Log In/Out> button.

NOTE: If you wish to filter access to the machine from the client computers, activate the IP Filter. The [Filter] screen is located in the same layer as the [TCP/IP Settings] screen.

Workstation Setup

This section explains how to change the workstation OS for Solaris, SunOS, and HP-UX workstations. Refer to the relevant instructions below.

Solaris – page 44

SunOS – page 44

HP-UX – page 46

Print language/mode/logical printer

A printer name for logical printer should correspond to the print language/mode to be used for printing, or to the Logical Printer Number which was registered through CentreWare Internet Services.

Printer Name	Print Language/Mode/Logical Printer
PS*	PostScript
PSASC/PSA*	PostScript
PSBIN/PSB*	PostScript
PCL	PCL
LP	Print language which was specified on the touch screen of the machine.
DUMP/DMP	Dump mode
AUTO/ATO	Auto detection mode
TIFF/TIF	TIFF direct print
TIFF%n	TIFF (%n: Logical Printer Number 1 to 10 which were registered through CentreWare Internet Services.)
PS%n*	PostScript (%n: Logical Printer Number 1 to 10 which were registered through CentreWare Internet Services.)

*: Option

You can also add output parameters to the above printer name. The parameters are the same as those for -C option. Insert “_” between the printer name and output parameter, for example “PS_A4”.

NOTE: If specifying a printer name other than above at printing, the print language or mode specified on the touch screen of the machine is used.

NOTE: When setting print languages/modes from the same workstation to a single printer, it is recommended to set one kind each. If two or more kinds of languages/modes are set, the workstation may display the same job number for some query (lpq).

NOTE: To print an ASCII-format PostScript file, specify PSASC for data processing with TBCP enabled.

NOTE: To print a binary-format PostScript file, specify PSBIN for data processing with TBCP disabled.

NOTE: When specifying PS, the machine functions as if PSBIN is specified.

NOTE: You cannot use -C option when specifying the printer name with the output parameter.

NOTE: For details about -C option, refer to *-C Option chapter on page 54*.

NOTE: Lowercase characters can also be used for a printer name.

NOTE: Up to 64 characters can be used for a printer name.

NOTE: Output parameters in the print data take priority over the printer name.

Solaris

Follow the steps below to set up a Solaris workstation to communicate with the machine.

1. Log in as root at a client workstation.
2. Use the Solaris ADMINTOOL to add the machine to the system host files.

NOTE: Refer to the Solaris documentation for instructions on using the ADMINTOOL.

- 1) Select [Browse].
- 2) Select [Printers].
- 3) Select [Edit].
- 4) Select [Add].
- 5) Select [Local Printer].
- 6) Enter the [Host Name] in the Printer Name field and then select [OK].
- 7) Select [File].
- 8) Select [Exit].

3. Verify connectivity to the machine, by using a UNIX command such as ping, as shown in the following example:

```
ping PrinterName
PrinterName is alive
```

NOTE: The remote queue name must be set to lp to spool jobs to the machine.

SunOS

Follow the steps below to set up a SunOS workstation to communicate with the machine.

1. Log in at a client workstation as root and add the machine to the /etc/hosts file.
For example:

```
IP address [tab] PrinterName
```

NOTE: If an NIS server is running on the same segment of the network as the machine, log in at the NIS server as root and add the machine to the master hosts file.
For example:

```
IP address [tab] PrinterName
```

2. Verify connectivity to the machine, by using a UNIX command such as ping, as shown in the following example:

```
ping PrinterName
PrinterName is alive
```

3. Edit the `/etc/printcap` file to contain an entry for the machine queue using the following example:

```
PrinterName:\
:lp=:\
:rm=PrinterName:\
:mx#0:\
:sd=/var/spool/lpd/PrinterName:\
:lf=/var/spool/lpd/PrinterName/log:
```

- 1) `PrinterName` is the local client name of the machine.
- 2) `lp=` is the local device name for the printer output. For remote printers, this parameter must be set to nothing.

NOTE: The recommended remote queue name is `lp`. That queue name will work with the machine.

- 3) `rm=` is the remote device. This is the IP hostname for the machine in the local client. The remote printer name defaults to `lp`, the default printer.
- 4) `mx#0` is the indicator that there is no limit on the document size.
- 5) `sd=` is the path of the queue for the machine.
- 6) `lf=` is the error log file name.

4. The machine can be designated as the location of the default print queue. It will then be unnecessary to include the `PrinterName` in the `lpr` command line.

- 1) To designate the machine for the default print queue, add the following to the `/etc/printcap` file. This is in addition to the information entered in the previous step:

```
lp PrinterName:\
:lp=:\
:rm=PrinterName:\
:mx#0:\
:sd-/var/spool/lpd/PrinterName:
```

5. Create the spool directory identified in the `printcap` file and set the access attributes, as shown in the example below. The spool directory should be located on a disk partition large enough to hold copies of documents that will be submitted.

```
cd /var / spool / lpd
mkdir PrinterName
chmod 744 PrinterName
```

HP-UX

Follow the steps below to set up an HP-UX workstation to communicate with the machine.

1. Log in as root at a client and add the machine to the `/etc/hosts` file. For example:

```
Ip address [tab] PrinterName
```

2. Verify connectivity to the machine, by using a UNIX command such as `ping` from a terminal command window, as shown in the following example:

```
ping PrinterName
```

NOTE: Select CTRL+C to cancel the ping command.

3. There are two methods to install the machine on an HP-UX workstation. Choose the method that will be used to complete the installation and refer to the appropriate page:

Using the Command Window TTY Method – page 46

Using the System Administrator Manager (SAM) GUI Method – page 47

Using the Command Window TTY Method

Follow the steps below to use the command window to manually enter command strings.

1. Open a command window on the desktop. From the command prompt (`#`), enter the information below. Remember that UNIX commands are case-sensitive.
 - 1) Type `su` to access the superuser mode.
 - 2) Type `sh` to run the Bourne shell.
 - 3) Type `lpshut` to stop the print service.
 - 4) Type the following command on one line:

```
lpadmin -pqueuename -v/dev/null -mrmmodel -ocmrcmodel-  
osmrsmodel -ob3 -orc -ormhostname -orplp
```

NOTE: The `queuename` is the name of the print queue being created. The `hostname` is the `PrinterName` for the machine from the `etc/hosts` file.

The remote queue name must be set to `lp` to spool jobs to the machine. This is set by the `-orplp` command.

2. Type `lpsched` to start the print service.
3. Type `enable queuename` to enable the queue to print to the machine.
4. Type `accept queuename` to enable the queue to start accepting jobs from the HP-UX workstation.

NOTE: The `queuename` is the name of the print queue that has been created.

5. Type `exit` to exit the Bourne shell.
6. Type `exit` to exit superuser mode.
7. Type `exit` to close the command window.

8. Continue with *Test Print on page 47*.

Using the System Administrator Manager (SAM) GUI Method

Follow the steps below to use the HP System Administrator Manager (SAM) GUI (Graphical User Interface).

NOTE: Refer to the HP-UX documentation for additional information on using the System Administrator Manager (SAM).

1. Start the SAM application.
2. Select the [Printers and Plotters] icon.
3. Select [Actions] from the Menu Bar.
4. Select [Add Remote Printer/Plotter] from the pull-down menu.
5. Enter the following information into the form displayed in the [Add Remote Printer/Plotter] dialog box:
 - 1) Printer Name
 - 2) Remote System Name
 - 3) For the Remote Printer Name, enter "lp".

NOTE: The Printer Name is the name of the print queue being created. The Remote System Name is the PrinterName for the machine from the etc/hosts file. The Remote Printer Name must be set to "lp" to spool jobs to the machine.

- 4) Enable Remote Printer on a BSD system by selecting the check box.
- 5) Make sure that the [Remote Cancel Model] is set correctly,
- 6) Make sure that the [Remote Status Model] is set correctly.
- 7) Make sure that the [Default Request Priority] is set correctly.
- 8) Make sure that the [Allow Anyone to Cancel a Request] check box is set correctly.
- 9) Make sure that the [Make This Printer the Default Destination] check box is set correctly.
6. Select [OK].
7. Read and respond to any displayed system messages.
8. Continue with *Test Print on page 47*.

Test Print

To make sure that the machine has been installed on the UNIX TCP/IP network correctly, a test print should be submitted from a client workstation. Perform the following steps.

1. Start the Open Windows application.
2. Send a test print to the machine.

3. Repeat the procedure for all workstations that will be sending jobs to the machine. The UNIX TCP/IP installation is now complete.
If the test print fails, refer to *Problem Solving chapter* for assistance.

Printing

Solaris/HP-UX

This section describes printing from workstations running Solaris or HP-UX. Refer to the manuals supplied with the workstation for full details.

Print (lp)

The lp command is used for printing.

Command format

```
lp [-d printer name] [-n number of copies] File name
```

Command options

The following command options are available.

- -d printer name

Specify the printer name registered by the lpadmin command as the -d option. If this option is omitted, the default printer lp will be used.

- -n number of copies

This option specifies the number of copies. If one lp command is issued to print multiple files, the number of copies specified will apply to all the files. However, this is only effective when the machine is in the spool mode. In the non-spool mode, the client must be a Windows NT machine to use this option.

NOTE: Some options which are not listed here (e.g. -m option) and which are not processed by the workstation sending the print instructions, will not be valid.

NOTE: In the spool mode, up to 32 files can be printed by one lp command. Any files specified after the 32nd file will be ignored.

Example

To print a file named file1 to a printer named fxPS, enter the following command:

```
%lp -dfxPS file1
```

To output three copies of file1 and then three copies of file 2 to fxPS, enter the following command:

```
%lp -dfxPS -n3 file1 file2
```

Delete (cancel)

The cancel command is used to delete print data.

Command format

```
cancel [printer name] [job number]
```

Command options

The following command options are available.

- `Printer name`

This option specifies the printer name. The cancel command can be effectively used with the combined use of `-a`, `-e` and `-u` as shown below. This option is only valid in the spool mode.

- `-a` Deletes all the print data belonging to the user issuing the command, from the specified printer.
- `-e` Deletes all the print data from the specified printer.
- `-u user name` Deletes all the print data belonging to the specified user, from the specified printer.

- `job number`

This option specifies the job number of the print data to be deleted. These numbers can be checked by issuing an `lpstat` command.

This option is only valid in the spool mode.

NOTE: Print data which consists of multiple files sent in one print instruction cannot be deleted file by file. All the files will be deleted together.

NOTE: This command is invalid if no options are specified, or if there is no print data which matches as the option.

NOTE: You can only delete print data from the same workstation used to send the print data. You cannot delete print data sent by other workstations.

NOTE: When a command to delete print data is received, the file will be deleted even if it is in the process of being printed. Any unprinted data will be cancelled after the file has been deleted.

Example

To delete the print data from printer `fxPS` for job number 27, enter the following command.

```
%cancel fxPS-27
```

To delete all the print data from printer `fxPS`, enter the following command.

```
%cancel fxPS -e
```

SunOS

This section describes printing from a workstation running SunOS. See the manuals supplied with the workstation for full details.

Print (lpr)

The lpr command is used to print.

Command format

```
/usr/ucb/lpr [-P printer name] [-# number of copies]
[-C parameter] File name
```

Command options

The following command options are available.

- -P printer name

This option specifies the printer name registered at /etc/printcap. If this option is omitted, print data will be output to the default printer lp.

- -# number of copies

This option specifies the number of copies. If one lpr command is issued to print multiple files, the number of copies specified by this option will apply to all the files.

This option is only valid in the spool mode.

- -C parameter

To print from the machine using the PostScript language, use the -C option to specify the form of output.

This option is valid in the spool mode. In the non-spool mode, the client must be a Windows NT machine to use this option.

NOTE: If the PostScript logical printer and the -C option are configured simultaneously using CentreWare Internet Services, some functions may not work as expected. Also, when specifying the PostScript logical printer as a default printer on UNIX, it is recommended not to use the -C option by lpr. Refer to the -C option of the lpr command.

NOTE: Some options which are not listed here (e.g. -m option) and which are not processed by the workstation sending the print instructions, will not be valid.

NOTE: In the spool mode, up to 32 files can be specified in one lpr command. Any files specified after the 32nd file will be ignored.

Example

To print a file named file1 to a printer named fxPS, enter the following command:

```
%lpr -PfxPS file1
```

To print three copies of file1 and three copies of file2 to fxPS, enter the following:

```
%lpr -PfxPS -#3 file1 file2
```

To print a file named file1 to a printer named fxPS as an A4-sized (210 × 297 mm/ 8.3 × 11.7 inches) duplex job, enter the following command:

```
%lpr -PfxPS -C,DUP,A4 file1
```

Delete (lprm)

The lprm command is used to delete print data.

Command format

```
/usr/ucb/lprm [-P printer name] job number
```

Command options

The following command options are available.

- `-P printer name`

This option specifies the printer name registered with `/etc/printcap`. If this option is omitted, the default printer `lp` will be used.

- `job number`

This option specifies the job number of the print data to be deleted. A job number is a serial number between 1 and 999 determined by the workstation. These numbers can be checked by issuing an `lpq` command.

Instead of a job number, you can specify a user name or “-”.

This option is invalid in the non-spool mode.

- `User name` is only valid when you log-in as a superuser. When this option is taken, all the print data you specify will be deleted.

This option is invalid in the non-spool mode.

- `-`

You can delete all your print data by specifying this option. If this option is issued by a superuser, all the print data received by the machine can be deleted.

This option is invalid in the non-spool mode.

NOTE: Print data which consist of multiple files sent in one print instruction cannot be deleted file by file. All the files will be deleted together.

NOTE: This command is invalid if no options are specified, or if there is no print data which matches as the option.

NOTE: You can only delete print data from the same workstation used to send the print data. You cannot delete print data sent by other workstations.

NOTE: When a command to delete print data is received, the file will be deleted even if it is in the process of being printed. Any unprinted data will be cancelled after the file has been deleted.

Example

To delete the print data from printer fxPS for job number 351, enter the following command:

```
%lprm -PfxPS 351
```

Printer Status

Solaris/HP-UX

The lpstat command is used to inquire about the status of the machine.

NOTE: In the non-spool mode, this function is available to Windows NT clients but not to HP-UX/Solaris clients.

Command format

```
lpstat [option]
```

Command options

The following command options are available.

If no option is specified, all the print data-related information will be displayed.

The sequence of the options does not affect the outcome.

To use more than one argument at the same time, separate them by commas and enclose all the arguments with “ ”.

E.g. %lpstat -u "user1,user2,user3"

- -o [printer name]

This option displays the print data for the specified printer.

- -t

This option displays all the information.

- -u [user name]

This option displays information about print data received from specified users.

- -v [printer name]

This option displays the printer name and the path name for the machine. The printer name is specified in the argument.

NOTE: Long file names will be truncated.

NOTE: Information for a maximum of 64 print instructions can be displayed.

NOTE: If two or more types of print languages/modes are set up on a single workstation, identical job numbers may be displayed when an inquiry command (lpstat) is issued.

Example

To inquire about the print data received by a printer named fxPS, enter the following command:

```
%lpstat -ofxPS
```

SunOS

The lpq command is used to inquire about the status of the machine.

NOTE: In the non-spool mode, this function is available to Windows NT clients but not to SunOS clients.

Command format

```
/usr/ucb/lpq [-P printer name] [-l] [user name]  
[+interval]
```

Command options

The following command options are available.

- -P printer name

This option specifies the printer name registered at /etc/printcap. If this option is omitted, the default printer lp will be used.

- -l

This option displays information about the workstation which is sending the print instruction in long format.

- User name

This option displays information about print data received from a specified user.

- +interval

This option is used to specify the inquiry interval period for the duration of printing, until all the data received has been printed. The interval is set up in seconds.

The screen of the client is refreshed each time the information is returned.

NOTE: Long file names will be truncated.

NOTE: Information for a maximum of 64 print instructions can be displayed.

NOTE: If two or more types of print languages/modes are set up on a single workstation, identical job numbers may be displayed when an inquiry command (lpq) is issued.

Examples

- To inquire about the print data received by a printer named fxPS, enter the following command:

```
%lpq -PfxPS
```

- To display a printer named fxPS in long format, enter the following command:

```
%lpq -PfxPS -l
```

-C Option

On SunOS, the -C option can be used to specify the print format if the machine prints with the PostScript language in spool mode.

This section explains the functions which can be specified and printing operations which will be affected using the -C option.

NOTE: When the PostScript logical printer that was configured using CentreWare Internet Services and the -C option have been specified simultaneously, some of the actions cannot be guaranteed to work. Also, when specifying the PostScript logical printer as a default printer on UNIX, it is recommended not to use the -C option.

Function

The following items can be set up using the -C option.

Selecting a paper tray

When selecting a paper tray, specify either a paper size or a tray. If the paper size is specified, the machine automatically searches and selects the tray.

The following parameters can be specified.

Parameter	Description
INTRAY1/intray1	Selects Tray 1.
INTRAY2/intray2	Selects Tray 2 (optional).
INTRAY3/intray3	Selects Tray 3 (optional).
INTRAY4/intray4	Selects Tray 4 (optional).
INTRAY5/intray5	Selects Tray 5 (manual feed).
INMF/inmf	Selects Tray 5 (manual feed).
A3/a3	Selects the tray which has A3 (297 × 420 mm/11.7 × 16.5 inches) paper loaded.
B4/b4	Selects the tray which has B4 (257 × 364 mm/10.1 × 14.3 inches) paper loaded.
A4/a4	Selects the tray which has A4 (210 × 297 mm/8.3 × 11.7 inches) paper loaded.

Parameter	Description
B5/b5	Selects the tray which has B5 (182 × 257 mm/7.2 × 10.1 inches) paper loaded.
A5/a5	Selects the tray which has A5 (148 × 210 mm/5.8 × 8.3 inches) paper loaded.
LETTER/letter	Selects the tray which has letter size (216 × 279 mm/8.5 × 11.0 inches) paper loaded.
LEGAL/legal	Selects the tray which has legal size (216 × 356 mm/8.5 × 14.0 inches) paper loaded.

NOTE: If several parameters are specified in the first lpr command, data may not be printed correctly.

NOTE: The system default is used if no tray number is specified, or a specified tray or specified size of paper is not loaded.

NOTE: This option is for specifying paper size only. Paper is selected but the document size is not resized to fit the actual paper size.

NOTE: If the print data specifies a paper tray, those specifications take priority over any -C option.

NOTE: If an invalid combination is specified, the machine may not operate correctly.

NOTE: For some print languages, the specification may be invalid.

Selecting a paper output tray

The following parameters can be specified.

Parameter	Description
OUTUP/outup	Delivers prints to the face-up tray.
OUTDOWN/outdown	Delivers prints to the face-down tray.

Selecting a paper type

The following parameters can be specified.

Parameter	Description
PTS/pts	Selects plain paper.
PT1/pt1	Selects thick paper 1.
PT2/pt2	Selects thick paper 2.
POH/poh	Selects transparency.
PTP/ptp	Selects tracing paper.

Parameter	Description
PLB/plb	Selects labels.
PQU/pqu	Selects bond paper.
PRC/prc	Selects recycled paper.

Specifying double-sided printing

The following parameters can be specified.

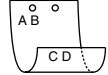
Parameter	Description
DUP/dup	Double-sided printing as follows: 
TUMBLE/tumble	Double-sided printing as follows: 
SIMP/simp	Single-sided printing

NOTE: If several parameters are specified in an lpr command, data may not print correctly.

NOTE: The system default is used if no parameter is specified.

NOTE: If the print data specifies double-sided or single-sided printing, those specifications take priority over any -C option.

Specifying paper size and double-sided printing

Select a paper size and a binding option. The following parameters can be specified:

Parameter	Description
A3D/a3d	Double-sided printing on A3 (297 × 420 mm/11.7 × 16.5 inches) paper and long-edge binding
A3T/a3t	Double-sided printing on A3 (297 × 420 mm/11.7 × 16.5 inches) paper and short-edge binding
A4D/a4d	Double-sided printing on A4 (210 × 297 mm/8.3 × 11.7 inches) paper and long-edge binding
A4T/a4t	Double-sided printing on A4 (210 × 297 mm/8.3 × 11.7 inches) paper and short-edge binding
B4D/b4d	Double-sided printing on B4 (257 × 364 mm/10.1 × 14.3 inches) paper and long-edge binding
B4T/b4t	Double-sided printing on B4 (257 × 364 mm/10.1 × 14.3 inches) paper and short-edge binding

Parameter	Description
A5D/a5d	Double-sided printing on A5 (148 × 210 mm/5.8 × 8.3 inches) paper and long-edge binding
A5T/a5t	Double-sided printing on A5 (148 × 210 mm/5.8 × 8.3 inches) paper and short-edge binding
B5D/b5d	Double-sided printing on B5 (182 × 257 mm/7.2 × 10.1 inches) paper and long-edge binding
B5T/b5t	Double-sided printing on B5 (182 × 257 mm/7.2 × 10.1 inches) paper and short-edge binding

NOTE: If several parameters are specified in an lpr command, data may not print correctly.

NOTE: The system default is used if no parameter is specified.

NOTE: If the print data specifies double-sided or single-sided printing, those specifications take priority over any -C option.

Specifying collation

The following parameter can be specified.

Parameter	Description
COLLATE/collate	Sorts prints electronically.

NOTE: For some print languages, the collation parameter may be invalid.

Specifying color and print modes

The following color and print mode parameters can be specified.

Parameter	Description
CC/cc	Selects color for color mode and quality priority for print mode.
CB/cb	Selects color for color mode and speed priority for print mode.
GC/gc	Selects monochrome for color mode and quality priority for print mode.
GB/gb	Selects monochrome for color mode and speed priority for print mode.
AC/ac	Selects auto (color/monochrome) for color mode and quality priority for print mode.
AB/ab	Selects auto (color/monochrome) for color mode and speed priority for print mode.

NOTE: The color setting is not available on the machine.

NOTE: If several parameters are specified in the first lpr command, data may not print.

NOTE: For some print languages, the color parameter may be invalid.

NOTE: The system default is used if no parameter is specified.

Specifying stapling

The following parameters can be specified for stapling.

Parameter	Description
STAPLETL	Places one staple in the upper left corner of the prints.
STAPLETD	Places two staples at the top of the prints.
STAPLETR	Places one staple in the upper right corner of the prints.
STAPLELD	Places two staples on the left side of the prints.
STAPLERD	Places two staples on the right side of the prints.
STAPLEBL	Places one staple in the lower left corner of the prints.
STAPLEBD	Places two staples at the bottom of the prints.
STAPLEBR	Places one staple in the lower right corner of the prints.

NOTE: The stapling setting is not available on the machine.

NOTE: If several parameters are specified in the first lpr command, data may not print.

NOTE: For some print languages, the stapling parameter may be invalid.

Printing

To specify the output format of printing, enter the following command:

```
-C, [parameter] , [parameter]
```

Enter a “,” (comma) after -C followed by the parameters which specify the output format. To specify multiple parameters, separate them with “,”.

For example, to print a file named “file1”, two-sided on A4 (210 x 297mm/8.3 x 11.7inches) on printer fxPS, enter the following command:

```
%lpr -PfxPS -C,DUP,A4 file1
```

NOTE: If the parameter string of the -C option exceeds 64 characters, the operation may not function correctly.

5 EtherTalk

This chapter explains how to set up the machine to operate on an EtherTalk network. The following information is provided.

Information Checklist – page 59

EtherTalk Environments – page 60

EtherTalk Installation – page 60

Installation Procedure – page 60

Network Communication Setup – page 60

Workstation Setup – page 62

Test Print – page 62

Information Checklist

Before installing EtherTalk on the machine, make sure that the following items are available or have been performed.

Item	By
An existing operational EtherTalk network with Macintosh workstations equipped with Ethernet network interface cards is required. These procedures are not designed to install an EtherTalk network.	Customer
Macintosh System versions 7.5 or later, 8.x, 9.x, or Mac OS X 10.2	Customer
Obtain and record the following information: <ul style="list-style-type: none">• IP address• Gateway address• Subnet mask• Host name Refer to the glossary for additional information about the Gateway Address and Subnet mask, if needed.	Customer
Test the machine to make sure that it is installed fully and functioning correctly.	Customer
Adobe PS print driver, or PPD (optional).	Customer

If problems are encountered during the machine installation, refer to *the Problem Solving chapter* for assistance.

CAUTION: Do not connect the network cable to the machine until instructed to do so.

EtherTalk Environments

System configuration

As the machine supports EtherTalk protocol, you can print from Macintosh.

NOTE: You will need the optional PostScript Kit to use EtherTalk for printing.

Target computers

The machine supports a Macintosh or Power Macintosh with the following OS:

- Mac OS 7.5 or later, 8.x, 9.x, or Mac OS X 10.2.

EtherTalk Installation

This section describes the installation procedure for using the machine in an EtherTalk Environment.

Installation Procedure

There are three stages required to install the machine on an EtherTalk network.

Network Communication Setup

This requires the machine to be set up for EtherTalk.

Workstation Setup

Install the print driver (Adobe PS) for Macintosh.

Test Print

A test print should be submitted to make sure that the machine has been installed and configured correctly.

Network Communication Setup

This procedure is used to set up the network communication parameters of the machine.

At the machine, perform these steps.

NOTE: Keep the SNMP port enabled while you use the machine on the TCP/IP network.

NOTE: CentreWare Internet Services can also be used to configure the machine. Refer to *CentreWare Internet Services chapter on page 91*.

Initially, boot the EtherTalk port.

1. Connect the machine to the network.

2. Press the <Log In/Out> button.
3. Select [System Settings].
4. Enter the password using the numeric keypad and then select [Confirm].
5. Select [Print Settings] and then press the <Enter> button.
6. Press the <Enter> button on the [Network/Port] screen.
7. Select [EtherTalk] by selecting [▼] or [▲] and then press the <Enter> button.
8. Select [Port Status] by selecting [▼] or [▲] and then press the <Enter> button.
9. Select [Enable] by selecting [▼] or [▲] and then press the <Enter> button.

If necessary, you may change the following setting.

- PjL

Next, establish TCP/IP.

1. Press the <Exit> button once or twice to display the [Network/Port] screen.
2. Select [TCP/IP Settings] by selecting [▼] or [▲] and then press the <Enter> button.
3. Select [Get IP Address] by selecting [▼] or [▲] and then press the <Enter> button.
4. Select [DHCP/Autonet], [DHCP], [BOOTP], [RARP], or [Manual] by selecting [▼] or [▲] and then press the <Enter> button.

NOTE: Use the DHCP server together with the Windows Internet Name Service (WINS) server.

If you selected [Manual] in step 4, use the following steps to enter the IP address.

If you selected other than [Manual], press the <Log In/Out> button and then go to *Workstation Setup on page 62*.

1. Press the <Exit> button.
2. Select [IP Address] by selecting [▼] or [▲] and then press the <Enter> button.
3. Use the numeric keypad to enter the IP address in the format "xxx.xxx.xxx.xxx".

NOTE: Press the <→> button to move to the next section. Press the <←> button to return to the previous section.

NOTE: You cannot enter 127, 254, or 255 into the first section of the format.

4. Press the <Enter> button.
5. Press the <Exit> button.
6. Use the same steps as IP address setting to enter the subnet mask and gateway address.

NOTE: You can enter 000, 128, 192, 224, 240, 248, 252, 254, or 255 into each section as the values for the subnet mask.

NOTE: You cannot enter 127, 254, or 255 into the first section of the format for the gateway address.

7. Press the <Log In/Out> button.

NOTE: If you wish to filter access to the machine from the client computers, activate the IP Filter. The [Filter] screen is located in the same layer as the [TCP/IP Settings] screen.

Workstation Setup

Install the print driver (Adobe PS) for Macintosh. Install the screen font if necessary. Refer to the PostScript User Guide.

Test Print

To make sure that the machine has been installed on the network correctly a test print should be submitted from a client workstation. Perform the following steps.

1. Open a sample document on a client workstation.
2. Select the machine using the Chooser (Mac OS 7.x through 9.x) or the Print Center (Mac OS X 10.2).
3. Print the document on the machine and verify that it prints correctly.
4. Make sure that the driver is installed on every workstation that will be sending jobs to the machine.
5. Repeat the test for all workstations that will be sending jobs to the machine.

The installation process is now complete.

If the test print fails, refer to *Problem Solving chapter* for assistance.

6 Microsoft Networking

This chapter explains how to set up the machine to operate on a Microsoft network. The following information is provided.

- Information Checklist – page 63*
- SMB Environments – page 64*
- SMB Installation – page 65*
- Installation Procedure – page 65*
- Network Communication Setup – page 65*
- Workstation Setup – page 67*
- Test Print – page 67*
- Changing the Settings – page 68*
- Procedure – page 68*
- Setting Format of config.txt – page 69*

Information Checklist

Before starting the Microsoft networking installation procedures, make sure that the following items are available or have been performed.

Item	By
An existing operational Microsoft network is required. These procedures are not designed to install a Microsoft network.	Customer
Obtain and record the following information, if required: <ul style="list-style-type: none">• IP address• Gateway address• Subnet mask• Host name Refer to the glossary for additional information about the Gateway Address and Subnet mask, if needed.	Customer
Test the machine to make sure that it is installed fully and functioning correctly.	Customer
Print driver for the machine	Customer

If problems are encountered during the installation, refer to *Problem Solving chapter* for assistance.

CAUTION: Do not connect the network cable to the machine until instructed to do so.

SMB Environments

Server Message Block (SMB) is a protocol for sharing files or printers on Windows OS. This section explains the installation procedure for connecting a printer to a Windows network through SMB.

System configuration

As the machine supports SMB protocol, you can send print data directly to the machine on the same network without going through the server.

You can use either NetBEUI, TCP/IP, or even both as the transport protocol for SMB. You will need to set up the IP address on the machine and the computer if you are using TCP/IP.

NOTE: Windows XP/Windows Server 2003 does not support NetBEUI.

NOTE: You can make SMB settings through CentreWare Internet Services. For more information on how to make SMB settings, refer to *CentreWare Internet Services chapter*.

Target computers

The following computers support printing through SMB.

Connection	OS	Protocol
Windows network	Windows 95 Windows 98 Windows Me	NetBEUI TCP/IP
	Windows NT 4.0	NetBEUI TCP/IP
	Windows 2000	NetBEUI TCP/IP
	Windows XP Windows Server 2003	TCP/IP

NOTE: NetBEUI is not recommended by Microsoft to be used as a protocol in new networks. It is recommended that this protocol is only used in small networks where existing legacy clients require it.

SMB Installation

This section describes the installation procedure for using the machine on an SMB network.

Installation Procedure

The installation procedure is as follows.

Network Communication Setup

When using NetBEUI:

Set the SMB port to [Enable] using the control panel or CentreWare Internet Services.

When using TCP/IP:

Set the SMB port to [Enable] using the control panel or CentreWare Internet Services. Set the IP address on the control panel.

Workstation Setup

Install the print driver on the computer.

Test Print

A print job should be submitted to make sure that the machine has been installed and configured correctly.

Network Communication Setup

This procedure is used to set up the network communication parameters of the machine.

At the machine, perform these steps.

NOTE: Keep the SNMP port enabled while you use the machine on the TCP/IP network.

NOTE: CentreWare Internet Services can also be used to configure the machine. Refer to *CentreWare Internet Services chapter on page 91*.

First, enable the SMB port.

1. Connect the machine to the network.
2. Press the <Log In/Out> button.
3. Select [System Settings].
4. Enter the password using the numeric keypad and then select [Confirm].
5. Select [Print Settings] and then press the <Enter> button.
6. Press the <Enter> button on the [Network/Port] screen.

7. Select [SMB] by selecting [▲] or [▼] and then press the <Enter> button.
8. Select [Port Status] by selecting [▲] or [▼] and then press the <Enter> button.
9. Select [Enable] by selecting [▲] or [▼] and then press the <Enter> button.

If necessary, you may change the following settings for SMB:

- Transport Protocol
- Print Mode
- PjL
- TBCP Filter

Next, establish TCP/IP if you use an IP address for a network.

If IP address setting is unnecessary, press the <Login/Out> button to go to *Workstation Setup on page 67*.

1. Press the <Exit> button once or twice to display the [Network/Port] screen.
2. Select [TCP/IP Settings] by selecting [▼] or [▲] and then press the <Enter> button.
3. Select [Get IP Address] by selecting [▼] or [▲] and then press the <Enter> button.
4. Select [DHCP/Autonet], [DHCP], [BOOTP], [RARP], or [Manual] by selecting [▼] or [▲] and then press the <Enter> button.

NOTE: Use the DHCP server together with the Windows Internet Name Service (WINS) server.

If you selected [Manual] in step 4, use the following steps to enter the IP address.

If you selected other than [Manual], press the <Login/Out> button and then go to *Workstation Setup on page 67*.

1. Press the <Exit> button.
2. Select [IP Address] by selecting [▼] or [▲] and then press the <Enter> button.
3. Use the numeric keypad to enter the IP address in the format “xxx.xxx.xxx.xxx”.

NOTE: Press the <→> button to move to the next section. Press the <←> button to return to the previous section.

NOTE: You cannot enter 127, 254, or 255 into the first section of the format.

4. Press the <Enter> button.
5. Press the <Exit> button.
6. Use the same steps as IP address setting to enter the subnet mask and gateway address.

NOTE: You can enter 000, 128, 192, 224, 240, 248, 252, 254, or 255 into each section as the values for the subnet mask.

NOTE: You cannot enter 127, 254, or 255 into the first section of the format for the gateway address.

7. Press the <Log In/Out> button.

NOTE: If you wish to filter access to the machine from the client computers, activate the IP Filter. The [Filter] screen is located in the same layer as the [TCP/IP Settings] screen.

Workstation Setup

Install the print driver on the client computer. Refer to the HTML documentation in CentreWare Utilities CD-ROM.

Test Print

Make sure that the machine has been installed on the network correctly by submitting a test print from a client workstation. Perform the following steps.

1. Open a document on a client workstation.
2. Select the machine as the printer.
3. Print the document on the machine and verify that it prints correctly.
4. Make sure that the print driver is installed on every workstation that will be sending jobs to the machine.
5. Repeat the test for all workstations that will be sending jobs to the machine.

The installation process is now complete.

If the test print fails, refer to *Problem Solving chapter* for assistance.

Changing the Settings

This section explains how the Key Operator uses [config.txt] to change the SMB settings.

Procedure

The steps below explain how to overwrite [config.txt] for the machine using a Windows networked computer. You will need the following information: SMB Host Name, Workgroup, Key Operator Name, and Key Operator Password.

1. Open [Network Neighborhood] from the Windows computer, followed by [Workgroup] (default: Workgroup) and then the [printer].

NOTE: The default host name of the machine is FX-xxxxxx, where xxxxxx is the last six characters of the MAC address of the machine. You can check the name by referring to SMB Host Name on the System Settings List.

NOTE: This method does not enable printer search across subnets. For printer search across subnets, you should set the WINS server or edit [LMHOSTS]. For details about [LMHOSTS], refer to your Windows manual.

2. Double click the [admintool] folder.
3. For Windows 95/Windows 98/Windows Me, enter the password (SMB Administrator Password) only. For Windows NT 4.0/Windows 2000/Windows XP, enter the user name (SMB Administrator Name) and password (SMB Administrator Password).
Then, click [OK]. The [admintool] folder will be opened.

NOTE: The factory default for the Key Operator Name is [admin], and the default Key Operator Password is "x-admin". You are advised to change the name and password from the default ones.

4. Open [config.txt] using a text editing application, for example Notepad.

NOTE: [Config.txt] can also be changed from CentreWare Internet Services.

5. Make changes to the appropriate items, and then save and close [config.txt].

NOTE: For more information about [config.txt], refer to *Setting Format of config.txt on page 69*.

The [message.txt] file is then created inside the [admintool] folder.

6. Open [message.txt] and check that it displays the information shown in the following table.

NOTE: If [message.txt] is not displayed, select [Refresh Status] from the [View] menu. If an error message appears, check the information has been set correctly in [config.txt].

7. Close [message.txt].

8. Switch off the machine. After the display on the screen clears, switch on the machine again.

NOTE: The changes you have made will be enabled either after switching off and on, or after saving [config.txt] with its Reboot option set to [Yes].

Setting Format of config.txt

Item	Remarks	Value	Default
Printer Language	Language to be used	English	English
Host Name	Host name of the machine	Maximum 15bytes	FX-xxxxxx (xxxxxx: last 6 characters of the MAC address of the machine)
Workgroup	Name of printer workgroup	Maximum 15bytes	WORKGROUP
NetBEUI	Activation of NetBEUI protocol	On/Off	On
TCP/IP	Activation of TCP/IP protocol	On/Off	On
Spool	Activation of spool function. Select from Disk, Memory, and Off. If Disk is selected but not recognized, Memory will be used.	Disk/Memory/Off	Disk
Max Spool Size	The maximum receive buffer size during spooling. Can be set in 256KB increments.	512–32768KB	1024KB
Max Receive Buffer Size	The maximum receive buffer size during non-spooling. Can be set in 32KB increments.	64–1024KB	256KB
JCL	Activation of JCL	On/Off	On
Print Mode	Set the printer language.	AUTO/PS*/PCL	AUTO
Auto Master Mode	Activation of the automatic browse master feature. Not available when WINS server is designated.	On/Off	On
Encrypt Password	Activation of the encrypt password feature.	On/Off	On
Time Zone	Set the time zone in units of minutes.	-720 to 720minutes	0 (GMT – Greenwich Mean Time)

Item	Remarks	Value	Default
Daylight Saving	Set the period of summer time. Set the time, date, and month for both the start date and end date of summer time. For example "1-012803-023110" will advance the system clock by one hour at 1 a.m. on 28th March, and go back one hour at 2 a.m. on 31st October.	hour-start-end (h-hhddmm-hhddmm)	
Maximum Sessions	Maximum connections of the machine.	3-10	5
Unicode Support	Enable the use of Unicode. If this is disabled then the local code, such as shift-JIS, will be used.	Enable/Disable	Disable
DHCP	Activation of DHCP.	On/Off	On
Get WINS DHCP	Activation of WINS DHCP.	Yes/No	Yes
IP Address	Set the IP address.	—	0.0.0.0
Subnet Mask	Set the subnet mask.	—	0.0.0.0
Gateway Address	Set the gateway address.	—	0.0.0.0
WINS Primary Server IP Address	Set the WINS primary server IP address.	—	0.0.0.0
WINS Secondary Server IP Address	Set the WINS secondary server IP address.	—	0.0.0.0
Administrator Name	Administrator name.	Maximum 20bytes	admin
Administrator Password	Password of Administrator. Current setting not displayed.	Maximum 14bytes	x-admin
Location	Comments on location of machine.	Maximum 48bytes	—
Reboot	Machine will reboot after editing the [config.txt] parameter setting file, if the reboot option is set to [Yes]. Usually set to [No] when activated. It will not reboot if there is an error in the setting, even if the reboot option is set to [Yes].	Yes/No	No

* Available only when PostScript Kit is installed.

7 TCP/IP (LPD or Port9100)

This chapter explains how to set up the machine to print from a Windows computer through LPD or Port9100. The following information is provided.

Information Checklist – page 71

TCP/IP (LPD or Port9100) Environments – page 72

TCP/IP (LPD or Port9100) Installation – page 72

Installation Procedure – page 72

Network Communication Setup – page 73

Workstation Setup – page 75

Test Print – page 75

Information Checklist

Before starting these procedures, make sure that the following items are available or have been performed.

Item	By
An existing operational network utilizing TCP/IP is required. These procedures are not designed to install a network.	Customer
Obtain and record the following information: <ul style="list-style-type: none">• IP address• Gateway address• Subnet mask• Host name Refer to the glossary for additional information about the Gateway Address and Subnet mask, if needed.	Customer
Test the machine to make sure that it is installed fully and functioning correctly.	Customer
Print driver for the machine	Customer

If problems are encountered during machine setup, refer to *Problem Solving chapter* for assistance.

CAUTION: Do not connect the network cable to the machine until instructed to do so.

TCP/IP (LPD or Port9100) Environments

System configuration

As the machine supports the LPD and Port9100 protocol, you can print directly from a Windows computer.

When printing from Windows 95/Windows 98/Windows Me computers through the LPD port, use our TCP/IP Direct Print Utility. This tool is installed together with the print drivers. When printing from Windows NT 4.0/Windows 2000/Windows XP/Windows Server 2003 computers, use the OS standard LPR port.

When printing through Port9100, change the necessary settings on the computers.

The transport protocol for LPD and Port9100 can be TCP/IP.

You will also need to set up the IP address on the machine and the Windows computers.

NOTE: Windows NT 4.0 does not support printing through Port9100.

Target computers

The following computers support printing through LPD or Port9100.

Connection	OS	Protocol
LPD port	Windows 95 Windows 98 Windows Me Windows NT 4.0 Windows 2000 Windows XP Windows Server 2003 Mac OS X	TCP/IP
Port9100	Windows 2000 Windows XP Windows Server 2003	TCP/IP

NOTE: The optional PostScript Kit is required when you print from Macintosh.

TCP/IP (LPD or Port9100) Installation

This section describes how to set up the machine to use the LPD and Port9100 protocol.

Installation Procedure

There are three stages to enable printing to the machine through LPD or Port9100.

Network Communication Setup

Enable the following ports using the control panel or CentreWare Internet Services.

- Printing through LPD: LPD port
- Printing through Port9100: Port9100 port

Set the IP address using the control panel.

NOTE: CentreWare Internet Services allows more detailed settings. Refer to *CentreWare Internet Services chapter on page 91*.

Workstation Setup

This requires the workstations in the networking environment to be configured to communicate with the machine.

Test Print

A print job should be submitted to make sure that the machine has been installed and configured correctly.

Network Communication Setup

This section describes how to set up the network communication parameters of the machine.

At the machine, perform these steps.

NOTE: Keep the SNMP port enabled while you use the machine on the TCP/IP network.

NOTE: CentreWare Internet Services can also be used to configure the machine. Refer to *CentreWare Internet Services chapter on page 91*.

First, enable the [LPD] or [Port9100] port.

1. Connect the machine to the network.
2. Press the <Log In/Out> button.
3. Select [System Settings].
4. Enter the password using the numeric keypad and then select [Confirm].
5. Select [Print Settings] and then press the <Enter> button.
6. Press the <Enter> button on the [Network/Port] screen.
7. Select [LPD] or [Port9100] by selecting [▼] or [▲] and then press the <Enter> button.
8. Select [Port Status] by selecting [▼] or [▲] and then press the <Enter> button.
9. Select [Enable] by selecting [▼] or [▲] and then press the <Enter> button.

If necessary, you may change the following settings for LPD or Port9100:

- Print Mode
- PJL
- Connect Time-out
- TBCP Filter
- Port No.

Next, establish TCP/IP.

1. Press the <Exit> button once or twice to display the [Network/Port] screen.
2. Select [TCP/IP Settings] by selecting [▼] or [▲] and then press the <Enter> button.
3. Select [Get IP Address] by selecting [▼] or [▲] and then press the <Enter> button.
4. Select [DHCP/Autonet], [DHCP], [BOOTP], [RARP], or [Manual] by selecting [▼] or [▲] and then press the <Enter> button.

NOTE: Use the DHCP server together with the Windows Internet Name Service (WINS) server.

If you selected [Manual] in step 4, use the following steps to enter the IP address.

If you selected other than [Manual], press the <Login/Out> button and then go to *Workstation Setup on page 75*.

1. Press the <Exit> button.
2. Select [IP Address] by selecting [▼] or [▲] and then press the <Enter> button.
3. Use the numeric keypad to enter the IP address in the format "xxx.xxx.xxx.xxx".

NOTE: Press the <→> button to move to the next section. Press the <←> button to return to the previous section.

NOTE: You cannot enter 127, 254, or 255 into the first section of the format.

4. Press the <Enter> button.
5. Press the <Exit> button.
6. Use the same steps as IP address setting to enter the subnet mask and gateway address.

NOTE: You can enter 000, 128, 192, 224, 240, 248, 252, 254, or 255 into each section as the values for the subnet mask.

NOTE: You cannot enter 127, 254, or 255 into the first section of the format for the gateway address.

7. Press the <Log In/Out> button.

NOTE: If you wish to filter access to the machine from the client computers, activate the IP Filter. The [Filter] screen is located in the same layer as the [TCP/IP Settings] screen.

Workstation Setup

Install print drivers on each client workstation that will be sending print jobs to the machine, and map to the machine as a printer. Refer to the HTML documentation in CentreWare Utilities CD-ROM or documentation provided with the optional PostScript Kit.

Test Print

To make sure that the machine has been installed on the network correctly, a test print should be submitted from a client workstation. Perform the following steps.

1. Open a document on a client workstation.
2. Select the machine as the printer to which the selected document will be sent.
3. Print the document on the machine and verify that it prints correctly.
4. Make sure that the driver is installed on every workstation that will be sending jobs to the machine.
5. Repeat the test for all workstations that will be sending jobs to the machine.

The installation process is now complete.

If the test print fails, refer to *the Problem Solving chapter* for assistance.

8 Parallel Port

This chapter explains how to set up the machine in a parallel port environment. The following information is provided.

Information Checklist – page 77

Parallel Port Environment – page 78

Parallel Port Installation – page 78

Installation Procedure – page 78

Parallel Port Communication Setup – page 78

Workstation Setup – page 79

Test Print – page 79

Information Checklist

Before starting the parallel port installation procedures, make sure that the following items are available or have been performed.

Item	By
IEEE1284 Parallel Port Cable	Customer
Test the machine to make sure that it is installed fully and functioning correctly.	Customer
Print driver for the machine	Customer

NOTE: The installation procedures will install the machine on the parallel port of the host workstation. The procedures are not intended to connect the host workstation to other workstations.

If problems are encountered during the installation of the machine, refer to *Problem Solving chapter* for assistance.

CAUTION: Do not connect the parallel port cable to the machine until instructed to do so.

Parallel Port Environment

System configuration

The machine can be connected directly to the parallel port of a host workstation. A document file can be sent from the host workstation via the parallel port to the machine for printing. Other workstations can be connected via a network to the host workstation. Each workstation has a queue that can hold a number of files.

The document file is sent from the queue in the workstation to the queue in the host workstation, and then onto the queue in the machine to be printed.

Target computers

The following computers support printing through the parallel port.

- Windows 95/Windows 98/Windows Me
- Windows NT 4.0/Windows 2000/Windows XP/Windows Server 2003

Parallel Port Installation

Follow these procedures to install and use the machine on the parallel port.

Installation Procedure

There are three stages required to install the machine on a parallel port.

Parallel Port Communication Setup

This requires the machine to be set up for parallel port printing.

Workstation Setup

This requires the workstation to be configured to print to the machine.

Test Print

A print job should be submitted to make sure that the machine has been installed and configured correctly.

Parallel Port Communication Setup

Connect the machine and the computer with an IEEE1284 Parallel Port Cable.

1. Insert the interface cable connector into the parallel interface connector of the machine and secure it using the wire clips on both sides.
2. Connect the other end of the interface cable connector to the computer.
3. Switch on the computer.

4. Switch on the machine.

Next, enable the Parallel port.

NOTE: CentreWare Internet Services can also be used to configure the machine. Refer to *the CentreWare Internet Services chapter*.

1. Press the <Log In/Out> button.
2. Select [System Settings].
3. Enter the password using the numeric keypad and then select [Confirm].
4. Select [Print Settings] and then press the <Enter> button.
5. Press the <Enter> button on the [Network/Port] screen.
6. Select [Parallel] by selecting [▼] or [▲] and then press the <Enter> button.
7. Select [Port Status] by selecting [▼] or [▲] and then press the <Enter> button.
8. Select [Enable] by selecting [▼] or [▲] and then press the <Enter> button.

Depending on your requirements, change the following communication parameters on the machine.

- Print Mode
- PjL
- Auto Eject Time
- Adobe Protocol
- Bi-directional

NOTE: Adobe Protocol can be set when the PostScript Kit (optional) has been installed.

NOTE: Except for Bi-directional, there is no need to change the default setting of the other items for normal use. However, it may be necessary to make changes depending on the OS of each computer.

9. Press the <Log In/Out> button.

Workstation Setup

Perform the following steps.

1. Refer to the HTML documentation on the CentreWare Utilities CD-ROM, and install the drivers for the machine on all the workstations that will be sending jobs to the machine.
2. Continue with *Test Print on page 79*.

Test Print

To make sure that the machine has been installed on the parallel port correctly, submit a test print from a client workstation. Perform the following steps.

1. Open a document on a workstation.
2. Select the machine as the printer to which the document will be sent.
3. Print the selected document on the machine and verify that it prints correctly.
4. Repeat the test for all workstations that will be sending jobs to the machine.

The installation process is now complete.

If the test print fails, refer to *the Problem Solving chapter* for assistance.

9 USB Port

This chapter explains how to set up the machine in a USB port environment. The following information is provided.

Information Checklist – page 81

USB Port Environment – page 82

USB Port Installation – page 82

Installation Procedure – page 82

USB Port Communication Setup – page 83

Workstation Setup – page 83

Test Print – page 84

Information Checklist

Before starting the USB port installation procedures, make sure that the following items are available or have been performed.

Item	By
USB Cable	Customer
Test the machine to make sure that it is installed fully and functioning correctly.	Customer
Print driver for the machine	Customer

NOTE: The installation procedures will install the machine on the USB port of the host workstation. The procedures are not intended to connect the host workstation to other workstations.

If problems are encountered during the installation of the machine, refer to *the Problem Solving chapter* for assistance.

CAUTION: Do not connect the USB cable to the machine until instructed to do so.

USB Port Environment

System configuration

The machine can be connected directly to the USB port of a host workstation. A document file can be sent from the host workstation via the USB port to the machine for printing. Other workstations can be connected via a network to the host workstation. Each workstation has a queue that can hold a number of files.

The document file is sent from the queue in the workstation to the queue in the host workstation, and then onto the queue in the machine to be printed.

Target computers

The following computers support printing through the USB port.

- Windows 2000/Windows XP/Windows Server 2003
- Mac OS X 10.2.x

NOTE: The optional PostScript Kit is required when you print from Macintosh.

USB Port Installation

Follow these installation procedures for using the machine on a USB port.

Installation Procedure

There are three stages required to install the machine on a USB port.

USB Port Communication Setup

This requires the machine to be set up for USB port printing.

Workstation Setup

This requires the workstation to be configured to print to the machine.

Test Print

A print job should be submitted to make sure that the machine has been installed and configured correctly.

USB Port Communication Setup

This section describes how to set up USB communication on the machine. The following parameters can be set depending on your requirements. These setups must be done without the USB cable connected.

Enable the USB port.

NOTE: CentreWare Internet Services can also be used to configure the machine. Refer to *CentreWare Internet Services chapter on page 91*.

1. Press the <Log In/Out> button.
2. Select [System Settings].
3. Enter the password using the numeric keypad and then select [Confirm].
4. Select [Print Settings] and then press the <Enter> button.
5. Press the <Enter> button on the [Network/Port] screen.
6. Select [USB] by selecting [▼] or [▲] and then press the <Enter> button.
7. Select [Port Status] by selecting [▼] or [▲] and then press the <Enter> button.
8. Select [Enable] by selecting [▼] or [▲] and then press the <Enter> button.

If necessary, you may change the following settings.

- Auto Eject Time
- Print Mode
- PJJ
- Adobe Protocol

NOTE: Adobe Protocol can be set when the PostScript Kit (optional) has been installed.

9. Press the <Log In/Out> button.

Workstation Setup

Before starting Workstation Setup, make sure that the USB cable is disconnected from the computer.

Then perform the following steps.

1. Refer to the HTML documentation in CentreWare Utilities CD-ROM or documentation provided with the optional PostScript Kit, and install the print drivers for the machine on all the workstations that will be sending jobs to the machine.
2. Continue with *Test Print on page 84*.

Test Print

To make sure that the machine has been installed on the USB port correctly, submit a test print from a client workstation. Perform the following steps.

1. Open a document on a workstation.
2. Select the machine as the printer to which the document will be sent.
3. Print the selected document on the machine and verify that it prints correctly.
4. Repeat the test for all workstations that will be sending jobs to the machine.

The installation process is now complete.

If the test print fails, refer to *the Problem Solving chapter* for assistance.

10 IPP (Internet Printing Protocol)

This chapter explains how to set up the machine to operate in an IPP (Internet Printing Protocol) environment. The following information is provided.

Information Checklist – page 85

IPP Environment – page 86

IPP Installation – page 86

Installation Procedure – page 86

Network Communication Setup – page 87

Workstation Setup – page 88

Test Print – page 88

Information Checklist

Before starting the IPP installation procedures, make sure that the following items are available or have been performed.

Item	By
An existing operational TCP/IP network is required. These procedures are not designed to install a network.	Customer
Obtain and record the following information: <ul style="list-style-type: none">• IP address• Gateway address• Subnet mask• Host name Refer to the glossary for additional information about the Gateway Address and Subnet mask, if needed.	Customer
Test the machine to make sure that it is installed fully and functioning correctly.	Customer
Print driver for the machine	Customer

If problems are encountered during the installation of the machine, refer to *Problem Solving chapter* for assistance.

CAUTION: Do not connect the network cable to the machine until instructed to do so.

IPP Environment

System configuration

The machine supports Internet Printing Protocol (IPP). As Windows 2000/Windows XP/Windows Me/Windows Server 2003 are installed with the client software needed to output to an IPP printer, you can specify this printer using the Add Printer Wizard. Using IPP, you can print to a remote printer through the Internet or intranet.

The transport protocol for IPP can be TCP/IP.

Target computers

The following computers support IPP.

Connection	OS	Protocol
TCP/IP	Windows 2000 Windows XP Windows Server 2003 Windows Me	TCP/IP

NOTE: For Internet printing from a Windows Me computer, the IPP port should be installed. For the IPP port installation, see the Windows Me documentation.

IPP Installation

Follow these procedures for installing and using the machine in an IPP environment.

Installation Procedure

There are three stages.

Network Communication Setup

This requires the machine to be set up for IPP.

Workstation Setup

This requires the workstation to be configured to print to the machine.

Test Print

A print job should be submitted to make sure that the machine has been installed and configured correctly.

Network Communication Setup

This section describes how to set up the network communication parameters of the machine.

At the machine, perform these steps.

NOTE: Keep the SNMP port enabled while you use the machine on the TCP/IP network.

NOTE: CentreWare Internet Services can also be used to configure the machine. Refer to *the CentreWare Internet Services chapter*.

Initially, enable the IPP port.

1. Connect the machine to the network.
2. Press the <Log In/Out> button.
3. Select [System Settings].
4. Enter the password using the numeric keypad and then select [Confirm].
5. Select [Print Settings] and then press the <Enter> button.
6. Press the <Enter> button on the [Network/Port] screen.
7. Select [IPP] by selecting [▼] or [▲] and then press the <Enter> button.
8. Select [Port Status] by selecting [▼] or [▲] and then press the <Enter> button.
9. Select [Enable] by selecting [▼] or [▲] and then press the <Enter> button.

If necessary, you may change the following settings.

- Print Mode
- PJJ
- Access Control
- DNS
- ADD Port No.
- Connect Time-Out
- TBCP Filter

Next, establish TCP/IP.

1. Press the <Exit> button once or twice to display the [Network/Port] screen.
2. Select [TCP/IP Settings] by selecting [▼] or [▲] and then press the <Enter> button.
3. Select [Get IP Address] by selecting [▼] or [▲] and then press the <Enter> button.
4. Select [DHCP/Autonet], [DHCP], [BOOTP], [RARP], or [Manual] by selecting [▼] or [▲] and then press the <Enter> button.

NOTE: Use the DHCP server together with the Windows Internet Name Service (WINS) server.

If you selected [Manual] in step 4, use the following steps to enter the IP address. If you selected other than [Manual], press the <Login/Out> button and then go to *Workstation Setup* on page 88.

1. Press the <Exit> button.
2. Select [IP Address] by selecting [▼] or [▲] and then press the <Enter> button.
3. Use the numeric keypad to enter the IP address in the format “xxx.xxx.xxx.xxx”.

NOTE: Press the <→> button to move to the next section. Press the <←> button to return to the previous section.

NOTE: You cannot enter 127, 254, or 255 into the first section of the format.

4. Press the <Enter> button.
5. Press the <Exit> button.
6. Use the same steps as IP address setting to enter the subnet mask and gateway address.

NOTE: You can enter 000, 128, 192, 224, 240, 248, 252, 254, or 255 into each section as the values for the subnet mask.

NOTE: You cannot enter 127, 254, or 255 into the first section of the format for the gateway address.

7. Press the <Log In/Out> button.

NOTE: If you wish to filter access to the machine from the client computers, activate the IP Filter. The [Filter] screen is located in the same layer as the [TCP/IP Settings] screen.

Workstation Setup

For each client workstation that will be sending print jobs to the machine, install the print drivers for the machine, and map to the machine as a printer. Refer to the HTML documentation in CentreWare Utilities CD-ROM, for additional information.

Test Print

To make sure that the machine has been installed on the network correctly a test print should be submitted from a client workstation. Perform the following steps.

1. Open a document on a client workstation.
2. Select the machine as the printer to which the selected document will be sent.
3. Print the document on the machine and verify that it prints correctly.

4. Make sure that the driver is installed on every workstation that will be sending jobs to the machine.

Repeat the test for all workstations that will be sending jobs to the machine.

The installation process is now complete.

If the test print fails, refer to *the Problem Solving chapter*. for assistance.

11 CentreWare Internet Services

This chapter explains how to enable and use the CentreWare Internet Services feature of the machine. The following information is provided.

Information Checklist – page 91

CentreWare Internet Services Environments – page 92

CentreWare Internet Services Installation – page 93

Installation Procedure – page 93

Network Communication Setup – page 93

Test Access – page 94

Using CentreWare Internet Services to Configure Settings on the Machine – page 95

Ethernet – page 95

Parallel – page 96

USB – page 96

EtherTalk – page 97

SMB (Microsoft Networking) – page 97

NetWare – page 98

TCP/IP – page 99

LPD – page 100

SNMP – page 101

IPP – page 101

Port9100 – page 102

UPnP – page 102

E-mail – page 103

HTTP – page 104

Information Checklist

Before enabling the CentreWare Internet Services feature, make sure that the following items are available or have been performed.

Item	By
An existing operational workstation with TCP/IP Internet or Intranet accessibility is required. These procedures are not intended to install the TCP/IP stack itself.	Customer

Item	By
Obtain and record the following information: <ul style="list-style-type: none"> • A Unique IP Address • Gateway Address • Subnet Mask Refer to the glossary for additional information about the Gateway Address and Subnet Mask, if needed.	Customer
Test the machine to make sure that it is installed fully and functioning correctly.	Customer

If problems are encountered during the installation of the machine, refer to *the Problem Solving chapter* for assistance.

CentreWare Internet Services Environments

CentreWare Internet Services uses the embedded HTTP Server on the machine. This allows communication with the machine through a Web browser with access to the Internet or intranet. By entering the internet address of the machine as the URL (Universal Resource Locator) in the browser, direct access to the machine is available.

CentreWare Internet Services allows you to make not only the same basic settings as from the control panel, but to also make more specialized settings for the machine.

Many of the features available within Internet Services will require an user name and password. The default user name is "admin" and the default password is "x-admin". A user will only be prompted for an admin name and password once in a single browser session.

System Configuration

To use CentreWare Internet Services, you need to enable TCP/IP on the machine.

Target Computers

The OS and browsers that can be used for CentreWare Internet Services are as follows.

OS	Browsers
Windows 98SE Windows Me Windows NT4.0	Internet Explorer 5.5 SP2, Internet Explorer 6.0 SP1 Netscape 7 NOTE: Activating two or more browsers could produce unexpected results.
Windows 2000	Internet Explorer 5.5 SP2, Internet Explorer 6.0 SP1 Netscape 7.1

OS	Browsers
Windows XP	Internet Explorer 6.0 SP1 Netscape 7.1
Windows Server 2003	Internet Explorer 6.0 SP1 Netscape 7.1
Mac OS 8.x, 9.x	Internet Explorer 5.1 Netscape 7.02
Mac OS X 10.2.6	Internet Explorer 5.2 Netscape 7.02

CentreWare Internet Services Installation

This section describes the settings required to use CentreWare Internet Services.

Installation Procedure

There are two stages required to enable CentreWare Internet Services.

Network Communication Setup

This requires the machine to be set up for CentreWare Internet Services.

Test Access

To make sure that CentreWare Internet Services has been set up correctly, you should access CentreWare Internet Services.

Network Communication Setup

Use this procedure to set up the network communication parameters of the machine.

At the machine, perform these steps.

First, enable the Internet Services port.

1. Connect the machine to the network.
2. Press the <Log In/Out> button.
3. Select [System Settings].
4. Enter the password using the numeric keypad and then select [Confirm].
5. Select [Print Settings] and then press the <Enter> button.
6. Press the <Enter> button on the [Network/Port] screen.
7. Select [Internet Services] by selecting [▼] or [▲] and then press the <Enter> button.
8. Select [Port Status] by selecting [▼] or [▲] and then press the <Enter> button.

9. Select [Enable] by selecting [▼] or [▲] and then press the <Enter> button.

Next, establish TCP/IP.

1. Press the <Exit> button once or twice to display the [Network/Port] screen.
2. Select [TCP/IP Settings] by selecting [▼] or [▲] and then press the <Enter> button.
3. Select [Get IP Address] by selecting [▼] or [▲] and then press the <Enter> button.
4. Select [DHCP/Autonet], [DHCP], [BOOTP], [RARP], or [Manual] by selecting [▼] or [▲] and then press the <Enter> button.

NOTE: Use the DHCP server together with the Windows Internet Name Service (WINS) server.

If you selected [Manual] in step 4, use the following steps to enter the IP address.

If you selected other than [Manual], press the <Login/Out> button and then go to *Test Access on page 94*.

1. Press the <Exit> button.
2. Select [IP Address] by selecting [▼] or [▲] and then press the <Enter> button.
3. Use the numeric keypad to enter the IP address in the format "xxx.xxx.xxx.xxx".

NOTE: Press the <→> button to move to the next section. Press the <←> button to return to the previous section.

NOTE: You cannot enter 127, 254, or 255 into the first section of the format.

4. Press the <Enter> button.
5. Press the <Exit> button.
6. Use the same steps as IP address setting to enter the subnet mask and gateway address.

NOTE: You can enter 000, 128, 192, 224, 240, 248, 252, 254, or 255 into each section as the values for the subnet mask.

NOTE: You cannot enter 127, 254, or 255 into the first section of the format for the gateway address.

7. Press the <Log In/Out> button.

NOTE: If you wish to filter access to the machine from the client computers, activate the IP Filter. The [Filter] screen is located in the same layer as the [TCP/IP Settings] screen.

Test Access

Follow the steps below to access CentreWare Internet Services.

1. At a client workstation on the network, launch an internet browser.

2. In the URL field, enter "http://" followed by the internet address of the machine. Then press the <Enter> key on the keyboard.

Example: If the internet address is vvv.xxx.yyy.zzz, enter the following in the URL field:

http://vvv.xxx.yyy.zzz

If the Port number is set, append that to the internet address as follows. In this example, the port number is 80.

http://vvv.xxx.yyy.zzz:80

3. Verify that the home page of CentreWare Internet Services is displayed.

The CentreWare Internet Services installation process is now completed.

If the test fails, refer to *Problem Solving chapter* for assistance.

NOTE: When your access to CentreWare Internet Services is encrypted, enter "https://" followed by the internet address, instead of "http://".

Using CentreWare Internet Services to Configure Settings on the Machine

This section provides the full listing of the items that can be set for each port through CentreWare Internet Services.

Refer to the CentreWare Internet Services chapter of the User Guide for more information. Select [Properties] > [Port Settings] to enable/disable each port.

NOTE: The following items display only if the port is activated. To activate a port through CentreWare Internet Services, select [Port Status], and then the required port.

Ethernet – page 95

Parallel – page 96

USB – page 96

EtherTalk – page 97

SMB (Microsoft Networking) – page 97

NetWare – page 98

TCP/IP – page 99

LPD – page 100

SNMP – page 101

IPP – page 101

Port9100 – page 102

UPnP – page 102

E-mail – page 103

HTTP – page 104

Ethernet

This page allows you to configure the Ethernet settings for the following options.

1. At the CentreWare Internet Services home page for the machine, select the [Properties] tab.
 2. In the [Properties] frame, select the plus symbol [+] to the left of the [Port Settings] folder.
 3. Select [Ethernet].
 4. Set up the following options to be displayed in the frame.
 - Ethernet Settings
- NOTE:** For more information about the options, refer to Properties in the CentreWare Internet Services chapter of the User Guide.
5. Select [Apply New Settings] to reflect the new setting.
 6. Enter the user ID and password, then select [OK].
- NOTE:** The default user ID is "admin" and the default password is "x-admin".
7. When the reboot message appears, select [Reboot].

Parallel

This page allows you to configure the parallel port settings for the following options.

1. At the CentreWare Internet Services home page for the machine, select the [Properties] tab.
 2. In the [Properties] frame, select the plus symbol [+] to the left of the [Port Settings] folder.
 3. Select [Parallel].
 4. Set up the following options to be displayed in the frame.
 - Bi-directional Communication
 - Auto Eject Time
 - Adobe Communication Protocol (Only available when the optional PostScript Kit is installed.)
- NOTE:** For more information about the options, refer to Properties in the CentreWare Internet Services chapter of the User Guide.
5. Select [Apply New Settings] to reflect the new setting.
 6. Enter the user ID and password, then select [OK].
- NOTE:** The default user ID is "admin" and the default password is "x-admin".

USB

This page allows you to configure the USB settings for the following options.

1. At the CentreWare Internet Services home page for the machine, select the [Properties] tab.

2. In the [Properties] frame, select the plus symbol [+] to the left of the [Port Settings] folder.
 3. Select [USB].
 4. Set up the following options to be displayed in the frame.
 - Auto Eject Time
 - Adobe Communication Protocol (Only available when the optional PostScript Kit is installed.)
- NOTE:** For more information about the options, refer to Properties in the CentreWare Internet Services chapter of the User Guide.
5. Select [Apply New Settings] to reflect the new setting.
 6. Enter the user ID and password, then select [OK].
- NOTE:** The default user ID is "admin" and the default password is "x-admin".
7. When the reboot message appears, select [Reboot].

EtherTalk

This is only available when the optional PostScript Kit is installed. This page allows you to configure the EtherTalk settings.

1. At the CentreWare Internet Services home page for the machine, select the [Properties] tab.
2. In the [Properties] frame, select the plus symbol [+] to the left of the [Protocol Settings] folder.
3. Select [EtherTalk].
4. Set up the following options to be displayed in the frame.
 - Printer Name
 - Zone Name
 - Printer Type

NOTE: For more information about the options, refer to Properties in the CentreWare Internet Services chapter of the User Guide.

5. Select [Apply New Settings] to reflect the new setting.
6. Enter the user ID and password, then select [OK].

NOTE: The default user ID is "admin" and the default password is "x-admin".

SMB (Microsoft Networking)

This page allows you to configure the SMB settings for the following options.

NOTE: Some settings on this page will only be available after you reboot the machine from CentreWare Internet Services, or after the machine is switched off and on.

1. At the CentreWare Internet Services home page for the machine, select the [Properties] tab.
2. In the [Properties] frame, select the plus symbol [+] to the left of the [Protocol Settings] folder.
3. Select [SMB].
4. Set up the following options to be displayed in the frame.
 - Workgroup
 - Host Name
 - Administrator Name
 - Administrator Password
 - Re-enter Password
 - Maximum Sessions
 - TBCP Filter (Only available when the optional PostScript Kit is installed.)
 - Unicode Support
 - Auto Master Mode
 - Encrypt Password

NOTE: For more information about the options, refer to Properties in the CentreWare Internet Services chapter of the User Guide.

5. Select [Apply New Settings] to reflect the new setting.
6. Enter the user ID and password, then select [OK].

NOTE: The default user ID is "admin" and the default password is "x-admin".

7. When the reboot message appears, select [Reboot].

NetWare

This page allows you to configure the NetWare settings for the following options.

NOTE: Some settings on this page will only be available after you reboot the machine from CentreWare Internet Services, or after the machine is switched off and on.

1. At the CentreWare Internet Services home page for the machine, select the [Properties] tab.
2. In the [Properties] frame, select the plus symbol [+] to the left of the [Protocol Settings] folder.
3. Select [NetWare].
4. Set up the following options to be displayed in the frame.
 - Host Name
 - Active Mode

- File Server Name
- Polling Interval
- Number of Searches
- Password
- Re-enter Password
- TBCP Filter (Only available when the optional PostScript Kit is installed.)
- Tree Name
- Context Name
- Transport Protocol
- Frame Type
- Network Address
- SLP
- Active Discovery

NOTE: For more information about the options, refer to Properties in the CentreWare Internet Services chapter of the User Guide.

5. Select [Apply New Settings] to reflect the new setting.

6. Enter the user ID and password, then select [OK].

NOTE: The default user ID is "admin" and the default password is "x-admin".

7. When the reboot message appears, select [Reboot].

TCP/IP

This page allows you to configure the following TCP/IP settings.

NOTE: Some settings on this page will only be available after you reboot the machine from CentreWare Internet Services, or after the machine is switched off and on.

- 1.** At the CentreWare Internet Services home page for the machine, select the [Properties] tab.
- 2.** In the [Properties] frame, select the plus symbol [+] to the left of the [Protocol Settings] folder.
- 3.** Select [TCP/IP].
- 4.** Set up the following options to be displayed in the frame.
 - Host Name
 - Get IP Address
 - IP Address
 - Subnet Mask
 - Gateway Address

- Get DNS Address
- DNS Address 1–3
- DNS Name
- Generate Domain Search List Automatically
- Domain Name 1–3
- Connection Time-Out
- Dynamic DNS Update
- Get WINS Server Address
- Primary WINS Server Address
- Secondary WINS Server Address
- IP Filter

NOTE: For more information about the options, refer to Properties in the CentreWare Internet Services chapter of the User Guide.

5. Select [Apply New Settings] to reflect the new setting.

6. Enter the user ID and password, then select [OK].

NOTE: The default user ID is "admin" and the default password is "x-admin".

7. When the reboot message appears, select [Reboot].

LPD

This page allows you to configure the LPD settings for the following options.

NOTE: Some settings on this page will only be available after you reboot the machine from CentreWare Internet Services, or after the machine is switched off and on.

1. At the CentreWare Internet Services home page for the machine, select the [Properties] tab.
2. In the [Properties] frame, select the plus symbol [+] to the left of the [Protocol Settings] folder.
3. Select [LPD].
4. Set up the following options to be displayed in the frame.
 - Port Number
 - TBCP Filter (Only available when the optional PostScript Kit is installed.)
 - Connection Time-Out

NOTE: For more information about the options, refer to Properties in the CentreWare Internet Services chapter of the User Guide.

5. Select [Apply New Settings] to reflect the new setting.

6. Enter the user ID and password, then select [OK].

NOTE: The default user ID is "admin" and the default password is "x-admin".

SNMP

This page allows you to configure the SNMP settings for the following options.

NOTE: Some settings on this page will only be available after you reboot the machine from CentreWare Internet Services, or after the machine is switched off and on.

1. At the CentreWare Internet Services home page for the machine, select the [Properties] tab.
2. In the [Properties] frame, select the plus symbol [+] to the left of the [Protocol Settings] folder.
3. Select [SNMP].
4. Set up the following options to be displayed in the frame.
 - Community Name (Read Only)
 - Community Name (Read/Write)
 - Community Name (Trap Notification)
 - Key Operator

NOTE: For more information about the options, refer to Properties in the CentreWare Internet Services chapter of the User Guide.

5. Select [Apply New Settings] to reflect the new setting.
6. Enter the user ID and password, then select [OK].

NOTE: The default user ID is "admin" and the default password is "x-admin".

IPP

This page allows you to configure the IPP settings for the following options.

NOTE: Some settings on this page will only be available after you reboot the machine from CentreWare Internet Services, or after the machine is switched off and on.

1. At the CentreWare Internet Services home page for the machine, select the [Properties] tab.
2. In the [Properties] frame, select the plus symbol [+] to the left of the [Protocol Settings] folder.
3. Select [IPP].
4. Set up the following options to be displayed in the frame.
 - Port Number
 - Add Port No.
 - TBCP Filter (Only available when the optional PostScript Kit is installed.)
 - Administrator Mode

- DNS
- Connection Time-Out

NOTE: For more information about the options, refer to Properties in the CentreWare Internet Services chapter of the User Guide.

5. Select [Apply New Settings] to reflect the new setting.
6. Enter the user ID and password, then select [OK].

NOTE: The default user ID is "admin" and the default password is "x-admin".

Port9100

This page allows you to configure the Port9100 settings for the following options.

NOTE: Some settings on this page will only be available after you reboot the machine from CentreWare Internet Services, or after the machine is switched off and on.

1. At the CentreWare Internet Services home page for the machine, select the [Properties] tab.
2. In the [Properties] frame, select the plus symbol [+] to the left of the [Protocol Settings] folder.
3. Select [Port9100].
4. Set up the following options to be displayed in the frame.
 - Port Number
 - TBCP Filter (Only available when the optional PostScript Kit is installed.)
 - Connection Time-Out

NOTE: For more information about the options, refer to Properties in the CentreWare Internet Services chapter of the User Guide.

5. Select [Apply New Settings] to reflect the new setting.
6. Enter the user ID and password, then select [OK].

NOTE: The default user ID is "admin" and the default password is "x-admin".

UPnP

This page allows you to configure the UPnP settings for the following options.

NOTE: Some settings on this page will only be available after you reboot the machine from CentreWare Internet Services, or after the machine is switched off and on.

1. At the CentreWare Internet Services home page for the machine, select the [Properties] tab.
2. In the [Properties] frame, select the plus symbol [+] to the left of the [Port Settings] folder.
3. Select [UPnP].

4. Set up the following option to be displayed in the frame.

- Port Number

NOTE: For more information about the options, refer to Properties in the CentreWare Internet Services chapter of the User Guide.

5. Select [Apply New Settings] to reflect the new setting.

6. Enter the user ID and password, then select [OK].

NOTE: The default user ID is "admin" and the default password is "x-admin".

7. When the reboot message appears, select [Reboot].

E-mail

This page allows you to configure the E-mail settings for the following options.

NOTE: Some settings on this page will only be available after you reboot the machine from CentreWare Internet Services, or after the machine is switched off and on.

1. At the CentreWare Internet Services home page for the machine, select the [Properties] tab.

2. In the [Properties] frame, select the plus symbol [+] to the left of the [Protocol Settings] folder.

3. Select [E-mail].

4. Set up the following options to be displayed in the frame.

- POP3 Server Address (Specify when the machine sends the E-mail using the POP before SMTP feature.)
- Max. no. of pages for Split Send
- POP User Name (Specify when the machine sends the E-mail using the POP before SMTP feature.)
- POP User Password (Specify when the machine sends the E-mail using the POP before SMTP feature.)
- Re-enter Password
- SMTP Send Authentication – POP before SMTP
- SMTP Server Address or Host Name. If Host Name is used, ensure that the DNS setting is correct. The DNS setting can be accessed from [Properties] > [Protocol Settings] > [TCP/IP].

NOTE: For more information about the options, refer to Properties in the CentreWare Internet Services chapter of the User Guide.

5. Select [Apply New Settings] to reflect the new setting.

6. Enter the user ID and password, then select [OK].

NOTE: The default user ID is "admin" and the default password is "x-admin".

7. When the reboot message appears, select [Reboot].

HTTP

This page allows you to configure the HTTP settings for the following options.

NOTE: Some settings on this page will only be available after you reboot the machine from CentreWare Internet Services, or after the machine is switched off and on.

1. At the CentreWare Internet Services home page for the machine, select the [Properties] tab.
2. In the [Properties] frame, select the plus symbol [+] to the left of the [Protocol Settings] folder.
3. Select [HTTP].
4. Set up the following options to be displayed in the frame.
 - Port Number
 - Maximum Sessions
 - Connection Time-Out

NOTE: For more information about the options, refer to Properties in the CentreWare Internet Services chapter of the User Guide.

5. Select [Apply New Settings] to reflect the new setting.
6. Enter the user ID and password, then select [OK].

NOTE: The default user ID is "admin" and the default password is "x-admin".

12 E-mail

This chapter describes how to set up the E-mail feature of the machine. The following information is provided.

E-mail Overview – page 105

Information Checklist – page 105

E-mail Environments – page 106

E-mail Installation – page 107

Installation Procedure – page 107

Network Communications Setup – page 107

Test E-mail – page 109

E-mail Overview

This section provides an overview of the settings for Scan to E-mail and Mail Notice Service features.

These features are available when the optional Scan to Email Kit is installed.

Scan to E-mail

You can send the scanned documents as an E-mail attachment to one or more E-mail address destinations. You can select the format of the scanned data to be TIFF or PDF.

Mail Notice Service

This feature enables you to set the machine to send E-mail to specified addresses about machine errors and print requests rejected by the filtering features.

Information Checklist

Before installing the feature, make sure that the following items are available or have been performed.

Item	By
An existing operational network utilizing TCP/IP is required. These procedures are not designed to install a network.	Customer

Item	By
Obtain and record the following information: <ul style="list-style-type: none"> • IP address • Gateway address • Subnet mask • Machine host name • Machine e-mail account • SMTP server address or SMTP server name • POP3 server address or POP3 server name • DNS server name (if mail server names are used instead of mail server addresses) Refer to the Glossary for additional information about the Gateway Address and Subnet mask, if needed.	Customer
Set up the mail server and E-mail accounts.	Customer
Test the machine to make sure that it is installed fully and functioning correctly.	Customer
Install the Scan to Email Kit.	Customer

NOTE: You must have an Internet Service Provider if you wish to acquire an E-mail account through ISP.

If problems are encountered during machine setup, refer to *the Problem Solving chapter* for assistance.

E-mail Environments

System Requirements

The following options are required for the machine.

- Scan to Email Kit
- The machine is connected to the network using TCP/IP.
- The environment allows the sending and receiving of E-mail.

Item	Correspondent Specifications
ITU-T Recommendations	ITU-T T.37, T.30, F.185 and E.164
E-mail format	RFC2304, RFC2305
DSN function	RFC1891, 1894
MDN function	RFC2298
SMTP	RFC821, 822, 1869
POP3	RFC1939
MIME version	Version1.0 (RFC2049)

NOTE: A file may not print if the format differs from those in the above table.

NOTE: It is recommended to use Microsoft Outlook Express 5.5/6.0 or Netscape 7 as an E-mail software.

E-mail Installation

This section describes how to enable the E-mail feature.

Installation Procedure

To use the E-mail feature, configure the following settings through CentreWare Internet Services.

Network Communication Setup

For more information, refer to *Network Communications Setup on page 107*.

NOTE: Before using CentreWare Internet Services, set the IP address for the machine.

Test Mail

The E-mail job should be submitted to make sure that the machine has been installed and configured correctly.

Network Communications Setup

Use this procedure to set up the network communication parameters of the machine.

At the machine, perform these steps.

NOTE: Keep the SNMP port enabled while you use the machine on the TCP/IP network.

NOTE: Some settings will only be available after you reboot the machine from CentreWare Internet Services, or after the machine is switched off and on.

First, set the following items.

1. At the CentreWare Internet Services home page for the machine, select the [Properties] tab.

NOTE: For more information about how to access the home page, refer to *CentreWare Internet Services chapter on page 91*.

2. In the [Properties] frame, select [Machine Details].
3. Enter the required E-mail address in [Administrator E-mail Address].
4. Select [Apply New Settings].
5. Enter the user ID and password, then select [OK].

NOTE: The default user ID is "admin" and the default password is "x-admin".

6. When the reboot message appears, select [Reboot].
7. In the [Properties] frame, select [Port Status].
8. Check [Enable] for [Send E-mail] and [Mail Notice Service]
9. Select [Apply New Settings].
10. When the reboot message appears, select [Reboot].

Next, set the E-mail feature.

1. At the CentreWare Internet Services home page for the machine, select the [Properties] tab.

NOTE: For more information about how to access the home page, refer to *CentreWare Internet Services chapter on page 91*.

2. In the [Properties] frame, select the plus symbol [+] to the left of the [Protocol Settings] folder.
3. Select [E-mail]
4. Set the following items.
 - POP3 Server Address or Host Name. Ensure that the DNS setting is correct if a POP3 server host name is used instead of the IP address. The DNS setting can be accessed from Properties > Protocol Settings > TCP/IP.
 - Max. no. of pages for Split Send
 - POP User Name
 - POP User Password
 - Re-enter Password
 - SMTP Send Authentication – POP before SMTP
 - SMTP Server Address or Host Name. Ensure that the DNS setting is correct if a SMTP server host name is used instead of the IP address. The DNS setting can be accessed from Properties > Protocol Settings > TCP/IP.

NOTE: Specify [POP3 Server Address], [POP User Name], and [POP User Password] when the machine sends the E-mail using the "POP before SMTP" Authentication feature.

5. Select [Apply New Settings].
6. When the reboot message appears, select [Reboot].

Finally, set the optional Mail Notice Service feature.

1. At the CentreWare Internet Services home page for the machine, select the [Properties] tab.

NOTE: For more information about how to access the home page, refer to *CentreWare Internet Services chapter on page 91*.

2. In the [Properties] frame, select [Mail Notice Settings].
3. Set the following items.
 - Notice Frequency - This setting specifies the frequency of sending the status of an e-mail to members of the Mail Recipient list.
 - Notice Day (Weekly) -- Specifies the day of the week that e-mails are sent if the Notice Frequency is set to Weekly.
 - Notice Date (Monthly) -- Specifies the date when the e-mails are sent if the Notice Frequency is set to monthly.
 - Notice Time -- Specifies the time of day to send the e-mail notice.
 - IP Reject Frequency -- Specifies the number of rejections before sending an e-mail notice to users whose IP addresses are not registered in the permitted addresses list.
 - Domain Reject Frequency -- Specifies the number of rejections before sending an e-mail notice to users whose domains are not registered in the permitted domains list.
 - Next Notice Date -- Displays the next transmission date.
 - Recipient Mail Address -- Specifies up to three recipient e-mail addresses for mail notices.
 - Regular Notice
 - IP Reject Notice
 - Domain Reject Notice
4. Select [Apply New Settings]

Test E-mail

Follow the steps below to test e-mail.

1. Load the documents.
2. Press the <E-Mail> button to select the features.
3. Specify the destination using the numeric keypad on the control panel.
4. Press the <Start> button.

The document will be scanned and converted to the format that you specified. Then it will be sent as an E-mail attachment.

13 Problem Solving

This chapter contains problem solving procedures and how to seek further assistance. For more information, refer to the following.

Problem Solving Procedures – page 111

Problems using a NetWare Environment – page 112

Problems using an SMB Environment – page 117

Problems using a UNIX Environment – page 119

Problems using a Windows Environment – page 121

Problems using EtherTalk – page 124

Problem using CentreWare Internet Services – page 125

Problem using Mail Notice Service – page 127

Problem Solving Procedures

This section enables you to identify the steps to solve problems relating to the network functions of the machine. Use the following steps to identify and solve the problem. If the problem is not network related, refer to the User Guide for corrective action.

1. Resolve any local copier or fax problems first. Perform the corrective action that is recommended by the User Guide. Do not attempt to resolve a network problem if the local copier and fax functions are not operating correctly.
2. Check that the machine has power and it is switched on.
3. Check that the network cable is connected to the machine.
4. Check that the network cable is connected to the workstation.
5. Check that the correct print driver for the machine is selected at the workstation.
6. Check that the software application being used to send print jobs is set up correctly.
7. If one workstation is not printing/faxing, then re-install the print driver on the workstation.
8. Call the local Xerox Welcome Center, where a representative will assist in the diagnosis and solution of the problem.

Problems using a NetWare Environment

This section explains what to do when problems occur while using NetWare. The causes, confirmation methods, and actions are as follows. If a problem still exists after the corrective action has been performed, follow the *Problem Solving Procedures on page 111* to seek further assistance.

When printing fails – page 112

When a switch off/on message is displayed – page 116

When the required printing result is not obtained – page 116

When there is no notification of error – page 117

When printing fails

*: For setting and confirmation methods, refer to the NetWare online documentation.

Cause	Confirmation Method	Action
A network component does not conform to the automatic setting of the frame type.	Check that the data link port light is on, in the network component connected to the machine. Then check that frame types of the file server are unified in the network.	Set the machine to the frame type specified for the file server to be connected.
A control character or an equal sign (=) was used in a printer name.	Check whether the machine is activated with the entered name.	Initialize the NV memory from the control panel of the machine, then specify a printer name with characters other than control characters or the equal sign (=).
A fault occurred on the network between the client and the machine.	Use NWADMIN to check whether the target printer object is viewed.	Replace the network cable between the client and the machine.
The user name or group name of the print job is not registered in the print queue.	Use NWADMIN or PCONSOLE to check whether the user name or group name of the job has been registered in the print queue.	<Action -1> Re-send the print job to a print queue in which the user name or group name has been registered correctly.
		<Action -2> Use NWADMIN or PCONSOLE to register a user name or group name of the job in the print queue.*
Print jobs cannot be sent to the print queue.	Use NWADMIN or PCONSOLE to check whether the Allow Users To Submit Print Jobs option is set to Yes.*	Use NWADMIN or PCONSOLE to set the Allow Users to Submit Print Jobs to Yes.*

Cause	Confirmation Method	Action
The user name or group name of the job is not defined in the print server.	Use NWADMIN or PCONSOLE to check whether the user name or group name of the job is registered in the target print server.*	<Action -1> Re-send the print job to a print queue in which the user name or group name has been registered correctly.*
		<Action -2> Use NWADMIN or PCONSOLE to register the user name or group name of the job in the print server.*
The print job is in a print queue that is not assigned to the machine.	Use NWADMIN or PCONSOLE to check whether the machine is assigned to the print queue.	<Action -1> Re-send the print job to the print queue assigned to the machine.*
		<Action -2> Use NWADMIN or PCONSOLE to assign the target queue to the machine.*
The number of print queues assigned exceeds the maximum number that the machine can support.	Use NWADMIN or PCONSOLE to check whether the required print queue is assigned to the machine.*	Re-send the print job to the print queue assigned to the machine.*
No slave file server is specified (bindery mode).	Use PCONSOLE to check whether a slave file server is registered.*	Use PCONSOLE to register a slave file server.*
Incorrect printer type.	Use PCONSOLE to check the printer type.*	Use PCONSOLE to specify [Remote Parallel, LPT1]. Then reboot the machine.*
The setting for the slave file server is incorrect (bindery mode).	Use PCONSOLE to check the setting.*	Use PCONSOLE to specify the correct setting.*
The actual number of the page of the print job is different from the page number set in the machine.	Use NWADMIN or PCONSOLE to check whether the starting paper number is the same as that of the print job.*	<Action -1> Use NWADMIN or PCONSOLE to match the [Starting paper] number with the paper number of the print job.*
		<Action -2> Use PCONSOLE to stop the print job. When the paper number is invalid, change the number, then re-send the print job to the print queue.

Cause	Confirmation Method	Action
The data format of the print job does not match the print environment setting of the client.	–	When printing a binary file in the PostScript language, make TBCP valid in the machine. If using Windows on the client, disable Ctrl-D. For details, refer the Windows PRINTER.WRI file.
The IPX checksum is set to an invalid level.	Use the Set command on the file server console to check whether the IPX checksum is set to level 0 or 2.	Enter the following command on the file server console to set the IPX checksum to level 1. Set Enable IPX Checksum = x (x: 1)
The NCP packet signature is set to an invalid level.	Use the Set command on the file server console to check whether the NCP packet signature is set to level 0 or 3.	Enter the following command on the file server console to set the NCP packet signature to level 1, and then restart the file server. set NCP Packet Signature Option = x (x: 1)
The connected server is set over the router when using TCP/IP.	Check whether the router can use multi-cast.	When the router cannot use multi-cast, install the NetWare5 server in the same network using TCP/IP. Then describe the address over the router in the [SYS:\ETC\SLP.CFG] file.
The IP address has been expired or has not been found when using the DHCP server.	Use the PING command to check whether the IP address of the machine is available.	Set the IP address.
Another printer object has been connected.	Use NWADMIN to check that the object is correctly assigned to the required print server.*	Use the CentreWare Utilities CD-ROM or CentreWare Internet Services to specify the correct file server name, tree name, context name, and active mode.
The file server goes down.	Select [Network Neighborhood] of Windows to search for the file server.	Activate the file server.
A printer having the same machine name exists on the network.	Switch off the machine, and then use NWADMIN to check that the printer object is in the job standby status.	Use the CentreWare Utilities CD-ROM to specify another machine name.

Cause	Confirmation Method	Action
The NetWare port is not activated.	<Confirmation -1> Print the System Settings List, then check that the port is activated.	<Action -1> Activate the NetWare port.
	<Confirmation - 2> Print the System Settings List. When using IPX/SPX, check that the network number remains set to 00000000 (NetWare server down). When using TCP/IP, check that the IP address remains set to 0.0.0.0 (fixed IP address not specified) or an address supply server (DHCP server down).	<Action -2> When using IPX/SPX, start the NetWare server. When using TCP/IP, set the fixed IP address or start the address supply server (DHCP).
Invalid printer configuration.	Use NWADMIN or PCONSOLE to check that the printer configuration is correct.*	Use NWADMIN or PCONSOLE to set the following items. Printer type: Parallel Port: LPT 1 Printer Location: Auto Load (Local).*
The default machine name is invalid.	Print the System Settings List, then check that the correct machine name is entered.	Specify the correct machine name (printer server name).
No directory tree name is specified.	Print the System Settings List, then check that a tree name is specified.	Specify a tree name.
No context is specified.	Print the System Settings List, and then check that a context is specified.	Specify a context.
The transport protocol of the NetWare port is not specified correctly.	Use CentreWare Internet Services to check that the transport protocol is also specified by the server.	Select the transport protocol that the server specifies.
A fault occurred during print processing.	Check the NetWare error of the machine displayed on the control panel.	Switch the machine off and on.

When a switch off/on message is displayed

Cause	Confirmation Method	Action
A fault occurred in the NetWare interface.	–	Switch the machine off and on.

When the required printing result is not obtained

Cause	Confirmation Method	Action
The specified print language of the print job is different from one specified in the machine.	Check the print language of the machine.	Specify the same print language of the print job as that of the machine.
Banner page print is specified for the job.	<Confirmation -1> When printing under the CAPTURE/NPRINT print job configuration, use the SHOW option to check that the banner flag is not specified.	<Action -1> When defining the CAPTURE/ NPRINT print job configuration, specify NOBANNER.
	<Confirmation -2> When printing from PCONSOLE under the print job configuration created with PRINTCON, check that the banner page print is available.	<Action -2> Inactivate the banner page print in the print job configuration with PRINTCON.
The file server and network are in the overload state.	–	<PServer mode> No action. <RPrinter mode> Extend the duration before timeout.
A fault occurred during print processing.	Check the NetWare error displayed on the control panel.	Switch the machine off and on.

When there is no notification of error

When there is no message displayed on the client which has sent print request, the possible causes, confirmation methods, and actions are as follows.

When there is no notification of printer error

Cause	Confirmation Method	Action
The user is not registered in the Notify list of the print server.	Use NAWADMIN or PCONSOLE to check whether the user name or group name of the job is registered.	Register the user name or group name of the job.

When there is no notification of the completion of the job

Cause	Confirmation Method	Action
When sending the print job from the client, the NOTIFY option is not specified.	When sending the print job, check whether the NOTIFY option has been specified.	When sending the print job, specify the NOTIFY option.
NetWareCASTOFF has been executed on the client.	–	Execute NetWareCASTON on the client.
When sending a job using NPRINT/CAPTURE/PCONSOLE, the NOTIFY option is not specified.	When sending the job using NPRINT/CAPTURE/PCONSOLE, check whether the NOTIFY option has been specified.	When sending the job using NPRINT/CAPTURE/PCONSOLE, specify the NOTIFY option.

Problems using an SMB Environment

This section explains what to do when a problem occurs while using SMB. The possible causes, confirmation methods, and actions are as follows. If a problem still exists after the corrective action has been performed, follow the *Problem Solving Procedures on page 111* to seek further assistance.

When the machine is not found from client computers – page 118

When printing fails – page 118

When the document cannot be deleted from the printer window – page 119

When the machine is not found from client computers

Cause	Confirmation Method	Action
The transport protocol is different between the client and the machine.	Select [Searching as another computer] ([Start] > [Find] > [Computer]) on the client, the machine can be found.	Match the SMB transport protocol between the machine and each client.
Multiple master browsers exist.	Same as the previous Confirmation Method	When multiple clients are in the same workgroup, set the [Auto Master Mode] item in the SMB setting file [config.txt] to OFF, then switch the power off and on. (Only the Key Operator)
The network (subnet) is invalid.	Same as the previous Confirmation Method	Set up the machine and client computer are in the same networks.
Host name search does not function correctly (with TCP/IP).	Use the PING command, and check that a response is returned when specifying the IP address of the machine, and that no response is returned when specifying the host name.	Check the WINS 1st server, WINS 2nd server, and subnet mask items in the SMB setting file [config.txt], and also check the WINS, DNS, and LMHOST contents in the client. (Only the Key Operator)
The host name specified for the machine is already defined for a different machine.	Check if the host name is duplicated in the SMB status information of the System Settings List.	Take one of the following actions. <ol style="list-style-type: none"> 1. Change the host name to a different name in the SMB setting file [Config.txt]. 2. Use CentreWare Internet Services to change the host name to a different name. 3. Reset the machine settings to the initial values. (Only the Key Operator)

When printing fails

Cause	Confirmation Method	Action
The machine is processing a print request from another client (only non-spool mode).	Check that the machine has a print job in progress.	After the machine has processed the print request, send a print job or change the mode to the spool mode.

Cause	Confirmation Method	Action
The number of sessions exceeds the maximum.	Check that the machine is processing simultaneous requests (such as print request or status inquiry request) from multiple clients. In Windows 95/Windows 98/Windows NT 4.0, the write error dialog, which indicates insufficient memory for the waiting print job is displayed.	Wait for a while, send a print request again. Alternatively, increase the [Maximum Sessions] in the SMB setting file [config.txt]. Then switch the power off and on. (Only the Key Operator)

When the document cannot be deleted from the printer window

Cause	Confirmation Method	Action
An attempt is made to delete all documents displayed in the printer window. (Only the Key Operator)	Check whether the attempt is made to delete the print job from the Printer menu in the printer window.	Delete the print job from the Document menu in the printer window.
The document owner is invalid.	Check whether the owner of the selected document matches the Windows log-in name.	Use the owner name of the document to log in to Windows, then delete the document.
Service Pack 4.0 or later is not installed in the system. (In Windows NT 4.0)	Check the Service Pack version displayed to be displayed when you start Windows NT 4.0.	Install Service Pack 4.0 or later.

Problems using a UNIX Environment

This section explains what to do when a problem occurs while using UNIX. The possible causes, confirmation methods, and actions are as follows. If a problem still exists after the corrective action has been performed, follow the *Problem Solving Procedures* on page 111 to seek further assistance.

When printing fails – page 119

When the required printing result is not obtained – page 121

When printing fails

Cause	Confirmation Method	Action
The IP address is not correct.	Check whether the IP address of the machine is correct.	Specify the correct IP address for the machine.

Cause	Confirmation Method	Action
A network error occurs on the network between the client and the machine.	Use the PING command to check the communication status.	Check the error.
The printer entry setting is not correctly defined on the client.	Check the printer entry setting on the client. Check the /etc/printcap file of the client or use the lpstat command to troubleshoot.	Define the correct printer entry setting.
The system is in offline.	Check if the online lamp is off.	Exit the pause or the machine setting mode, and then check if the online lamp comes on.
The print data size sent in one print command exceeds the buffer memory size (in spool mode).	Check the upper limit of the receiving data size, and then compare it with the size of print data to be sent as one job.	<Action -1> When the print data size exceeds the maximum receiving data size in one file, divide the file into files smaller than the maximum, then re-send the print request.
		<Action -2> When the print data size exceeds the maximum receiving data size in multiple files, reduce the number of files to be printed at one time.
A fault occurred during print processing.	Check the LPD error message displayed on the control panel.	Switch the machine off and on.
The specified transmission speed is different from the transmission speed of the network.	Check whether the transmission speed is specified correctly.	Specify the correct transmission speed.
The client and machine are in different rings connected via a bridge, and the source routing is inactivated.	Check whether the source routing is specified correctly.	Activate the source routing.
The data format of the print job does not match the print environment of the client (print data sent from the client contains TBCP).	-	Specify PSASC as the printer name.

Cause	Confirmation Method	Action
The data format of the print job does not match the print environment of the client (print data sent from the client is in the binary notation).	–	Set the logical printer name to PSBIN to print a binary file in the PostScript language.
Print paper is out.	Check the paper refilling message on the control panel.	Load the paper into the paper tray. When changing the paper size, specify the new size, if required.
The selected transport protocol does not match the client.	Check the transport protocol selected from the control panel.	Select the transport protocol matching the client.

When the required printing result is not obtained

Cause	Confirmation Method	Action
The specified print language is different from the print language of the print data.	Check the specified print language and the print language of the print data.	Specify a print language matching that of the print data.

Problems using a Windows Environment

This section explains what to do when a problem occurs while using Microsoft Windows OS. The possible causes, confirmation methods, and actions are as follows. If a problem still exists after the corrective action has been performed, follow the *Problem Solving Procedures on page 111* to seek further assistance.

When using Windows 95/Windows 98/Windows Me – page 122

When using Windows NT 4.0/Windows 2000/Windows XP/Windows Server 2003 – page 123

When using Windows 95/Windows 98/Windows Me

When printing fails

The following table explains what action to take when a printer disabled status (network error) or (spool error) is displayed when you click [Start] > [Settings] > [Printers] on your computer.

Cause	Confirmation Method	Action
The machine is connected to a network that is not available to your computer.	Check whether a router or gateway is between the network connected to your computer and one connected to the machine.	Directly connect the machine to the network connected to your computer.
A fault occurred on the network between your computer and the machine; connection failed.	Check that printer disabled status (network error) is displayed.	Check the network fault.
An invalid IP address is specified for the machine.	Print disabled status (Network Error) is displayed. Select [Properties] from the [Printer] menu on the printer window, and also select [Port Settings] on the [Details] tab. Compare the IP addresses in the [FX TCP/IP DPU Port Setups] and the System Settings List.	Enter the correct IP address in the IP address item of the [FX TCP/IP DPU Port Setup] dialog box.
After a print request was sent from the computer, the machine was switched off, or a print request was sent to a machine that was not switched on.	Print disabled status (Network Error) is displayed. Check whether the machine is switched on.	Switch the machine on.
Print requests are sent from multiple computers to the machine at the same time.	Print disabled status (Network Error) is displayed.	None. Printing restarts automatically.
Printing file cannot be spooled due to insufficient disk capacity of the computer.	Print disabled status (spool error) is displayed. Open [My Computer], then right-click the disk (example: C drive) in which Windows 95/Windows 98/Windows Me is installed. Select [Properties] from the displayed menu, and then check the free space size.	After deleting unnecessary files to increase the free space available, select [Pause Printing] from the [Document] menu of the printer window to enable printing to restart.

When using Windows NT 4.0/Windows 2000/Windows XP/Windows Server 2003

When printing fails

Cause	Confirmation Method	Action
The correct IP address is not specified.	Check whether the IP address of the machine is correct.	Specify the correct IP address for the machine.
When [lpd spool] is set to memory, the size of print data sent in one print request exceeds the maximum size specified.	Check the maximum receiving data size on the touch screen of the machine, and then compare it with the size of print data to be sent as one request.	<Action -1> When the print data size exceeds the maximum size in one file, divide the file into smaller files than the maximum receiving data size, then send the print request again.
		<Action -2> When the print data size exceeds the maximum size in multiple files, reduce the number of files to be printed at one time.
A fault occurred during print processing.	Check the error message on the touch screen.	Write down the error message, switch the machine off and on, and retry printing. If the problem still exists, contact your Xerox Welcome Center.
The selected transport protocol does not conform with the client.	Check the selected transport protocol on the touch screen.	Select a transport protocol conforming with the client.
The print data format to be processed by the machine does not match the data format sent from the client.	—	Disable the output function of Ctrl-D.

When the required printing result is not obtained

Cause	Confirmation Method	Action
The specified print language is different from the print language of the print data.	Check the specified print language and the print language of the print data.	Specify a print language matching that of the print data.

Cause	Confirmation Method	Action
The print driver that accompanies the machine is not being used (a third party print driver is being used).	Check whether the print driver that accompanies the machine is selected.	Select the print driver that accompanies the machine. If the print driver is not found, install and select it. If a third party print driver is used, you may have unexpected results.

Problems using EtherTalk

This section explains what to do when a problem occurs while using EtherTalk. The possible causes, confirmation methods, and actions are as follows. If a problem still exists after the corrective action has been performed, follow the *Problem Solving Procedures on page 111* to seek further assistance.

Cause	Confirmation Method	Action
The name (or the default name) of the machine has been changed.	Check that the machine name has been changed in Chooser.	Change the name of the machine or the other printer to avoid the same name on the network.
The machine does not display in Chooser.	Use a network management software to check that the type of the NBP entity name for the machine has been changed from LaserWriter.	If the type of NBP entity name for the machine has been changed from LaserWriter, the machine cannot be selected in Chooser. If the machine must be selected, open the machine using Apple Share Print Server or Windows Server.
	Use a network management software to check that the machine exists on the network. Check that the network is connected correctly.	If the machine cannot be found on the network, the machine may be off or the network cable may be faulty. If the machine is on or the network cable is not faulty, contact the Xerox Welcome Center.

Cause	Confirmation Method	Action
Unable to obtain the required print results.	Check that the print language between the machine and the print driver are consistent.	Select the print language correctly. If the print language of the machine is in the dump mode, the data sent from the Macintosh will be printed in hexadecimal notations.
	Check the installation procedure for the print driver. Check the print driver which came with the machine displays in Chooser.	Install the print driver correctly. If a print driver of a third party is used, you may have unexpected results. If garbled characters are still printed, contact the Xerox Welcome Center.
The machine is not connected.	Check that the machine is selected in Chooser. If the machine is processing another job, the job must be completed before the machine can be connected.	Select the machine in Chooser.
	Check that the EtherTalk port is activated or the machine is in the offline mode.	Activate the port or exit the offline mode. If the machine still cannot be connected, contact the Xerox Welcome Center.
Although the machine is connected, the machine does not print.	Check that the machine is switched on, paper jam has occurred in the machine, or the network is faulty.	If the problem remains, contact the Xerox Welcome Center.
A message to reboot the machine is displayed on the screen.	Check that the EtherTalk function has failed.	Switch the machine off and on. If the message still displays, contact the Xerox Support Center.

Problem using CentreWare Internet Services

This section explains what to do when a problem occurs while using CentreWare Internet Services. The possible causes, confirmation methods, and actions are as follows. If a problem still exists after the corrective action has been performed, follow the *Problem Solving Procedures on page 111* to seek further assistance.

Cause	Confirmation Method	Action
Cannot access to CentreWare Internet Services.	Check if the machine is switched on.	Switch the machine on.
	Print out the System Settings List to check if CentreWare Internet Services port is activated.	Activate the CentreWare Internet Services port.
	Check if the internet address is correctly entered.	Check the internet address. If Services cannot be accessed, enter the IP address to make the connection.
	Check if the proxy server being used.	Depending on the proxy server, connections might not be possible. Without using the proxy server, configure either the browser setting to "not using proxy server" or the address to be used to "not using proxy server".
The "please wait" message is displayed.	–	Wait for a while as instructed. If nothing happens, click the [Refresh Status] button. If this does not help, check that the machine is working correctly.
The [Refresh Status] button is not working.	Check if you are using the specified OS and browser.	Use the specified OS and browser.
Selecting menu in the left frame does not change the right frame connection.		
The screen display is distorted.	–	Change the window size of the browser.
The latest information is not displayed.	–	Click the [Refresh Status] button.
Clicking the [Apply New Settings] button does not reflect the new settings.	Check if the entered value is correct.	Enter the correct value. If the entry is not valid, it will be automatically changed within the limit.
Clicking the [Apply New Settings] button will display messages like "the server has returned ineffective or unrecognizable response" or "no data".	Check if the user ID and password are correct.	Enter the correct user ID and password.
		Reboot the machine.

Cause	Confirmation Method	Action
Cannot delete the job.	–	Wait for a while and then click the [Refresh Status] button.

Problem using Mail Notice Service

This section explains what to do when a problem occurs while using Mail Notice Service feature. The possible causes, confirmation methods, and actions are as follows. If a problem still exists after the corrective action has been performed, follow the *Problem Solving Procedures on page 111* to seek further assistance.

Cause	Confirmation Method	Action
Mail Notice Service does not notify the machine status.	Use CentreWare Internet Services to check if the E-mail address of the machine is set.	Set the E-mail address of the machine.
	Use CentreWare Internet Services to check if [Mail Notice Service] is activated.	Activate [Mail Notice Service].
	Use CentreWare Internet Services to check if the SMTP Server IP Address or POP3 Server IP Address is set correctly.	Set the SMTP Server IP Address or POP3 Server IP Address.
	Use CentreWare Internet Services check if the POP3 Server Login Name or POP3 Server Password is set correctly.	Set the POP3 Server Login Name or POP3 Server Password.
	Use CentreWare Internet Services to check if the Mail Notice settings are set correctly.	Set the Mail Notice settings.
	Use CentreWare Internet Services to check if the recipient mail addresses are set correctly.	Set the recipient mail addresses.
	Check if your SMTP or POP3 server function correctly.	Check your SMTP or POP3 server.

14 Glossary

This chapter contains a list of terms used in the System Administration Guide. Each term has a corresponding definition that reflects the meaning of the term as it is used in this Guide.

Terms Defined

Use the following definitions to learn more about the meanings of terms used in this Guide.

10Base-T	A specification for baseband Ethernet running up to 10-Mbps on two pairs of twisted-pair wiring: one pair for transmitting data and the other for receiving. To guarantee proper signal timing, 10BaseT has a distance limit of approximately 100 meters per segment. Based on the IEEE 802.3 standard. See also Ethernet and IEEE.
100Base-TX	A specification for baseband Ethernet running up to 100-Mbps on two pairs of twisted-pair wiring: either UTP or STP. The first pair of wires is used to receive data; the second is used to transmit. To guarantee proper signal timing, 100BaseTX has a distance limit of approximately 100 meters per segment. Based on the IEEE 802.3 standard. See also Ethernet, and IEEE.
ASCII	An abbreviation of American Standard Code for Information Interchange. A coding scheme that assigns numeric values to letters, numbers, punctuation, and certain other characters.
BOOTP	An abbreviation of Bootstrap Protocol. This is a protocol used by a network node to determine the IP address of its Ethernet interfaces, in order to boot a computer from a server via a network.
Client Server	A network environment in which the nodes communicate with a file server, and not directly with other nodes.
DHCP	An abbreviation of Dynamic Host Configuration Protocol. A protocol allowing the principal parameters of network devices (including IP Addresses) to be configured by central DHCP servers.
DNS	An abbreviation of Domain Name System. A system used in the Internet for translating names of network nodes into addresses.

Driver	Software that is loaded on the client workstation that prepares data to be sent to the machine.
Ethernet	Network transport technology commonly used to send data from one network node to another.
FTP	An abbreviation of File Transfer Protocol. An application protocol, part of the TCP/IP protocol stack, used for transferring files between network nodes.
Gateway Address	The Gateway Address is the IP Address of the gateway, or router, that the machine will use to access devices on other subnets.
HTTP	An abbreviation of Hyper Text Transfer Protocol. This is the Internet standard that supports the exchange of information on the World Wide Web (WWW). HTTP lays the foundation for transparent access to the Internet.
IEEE	An abbreviation of Institute of Electrical and Electronics Engineers. This is an organization of engineering and electronics professionals notable for developing the IEEE 802 standards for the physical and data-link layers of local area networks, following the ISO Open Systems Interconnection (OSI) model.
IP	See TCP/IP
IP Address	See TCP/IP
IPP	An abbreviation of Internet Printing Protocol. This is a sanctioned Internet Engineering Task Force (IETF) standard for printing documents from the Internet. IPP was initially conceived between Novell and Xerox with necessary support from the IETF.
IPX	Internetwork Packet Exchange. IPX is part of NetWare. It routes packets to the correct node and to the correct process within the node.
LAN	An abbreviation of Local Area Network. This is a network that serves a relatively small area, such as one building, and does not require telecommunications services to reach all of the nodes.
LPD	An abbreviation of Line Printer Daemon. This is a print management program that runs on a host.
NDS	An abbreviation of Novell Directory Services that was formerly known as NetWare Directory Services. This is a database used by Novell NetWare to organize resources for an entire network of NetWare servers. The database itself can be distributed across the network and accessed by all servers.

NetBEUI	An abbreviation of NetBIOS (Network Basic Input/Output System) Extended User Interface. It is an enhanced version of the NetBIOS protocol that is used by network operating systems, such as LAN Manager, LAN Server, Windows for Workgroups, and Windows NT. NetBEUI formalizes the transport frame and adds additional functions.
NetWare	A network operating system from Novell. Clients log onto one or more file servers, which provide services such as e-mail, printing, and filing.
Node	A device on a network that has an address and can send and/or receive data to and from other devices on the network.
PCL	An abbreviation of Printer Control Language, which is used by Hewlett-Packard. This is a set of commands that tells a printer how to print a document.
PCL5e	A Hewlett-Packard Printer Control Language (PCL) that is the first version of PCL to support bi-directional communication between printer and computer.
PCL6	A Hewlett-Packard Printer Control Language (PCL). It is an interpreted language, similar to but more intelligent than PostScript. This version offers significant changes in the backward compatibility issue for Hewlett-Packard machines.
PCONSOLE	A NetWare utility that can be used to create, configure, monitor, and manage queues in a NetWare server, and to attach print servers to the queues.
PDF	An abbreviation of Portable Document Format. It is a file format developed by Adobe Systems. A PDF file can describe documents containing text and images, retaining all the formatting and fonts of the original copy. The document can then be displayed or printed, using application software, hardware, or operating system, which may differ from that used to create the original document.
PDL	An abbreviation of Page-Description Language. This refers to a programming language, such as PostScript, that is used to describe output to a printer or a display device, which then uses the instructions from the PDL to construct text and graphics and create the required page image.
Peer-to-Peer	A network environment in which the nodes communicate directly with other nodes. Windows for Workgroups, NetWare Lite, and Macintosh System 7 are examples of peer-to-peer networking products.
PostScript	PostScript is a page description language (PDL) developed by Adobe Systems. It is an object-oriented language, meaning that it treats images, including fonts, as collections of geometrical objects rather than as bit maps. PostScript is the standard for desktop publishing because it is widely supported by both hardware and software vendors.

Print driver	See Driver.
Protocol	The rules that control the transmitting and receiving of data.
Queue	A place where jobs are stored temporarily, while they are waiting to be processed. A print queue will hold several print jobs.
RARP	An abbreviation of Reverse Address Resolution Protocol. This is a method for providing IP Addresses to nodes on a network. When a node powers up, it broadcasts a RARP packet containing its Ethernet Address. The RARP server receives the packet and sends the IP Address back to the node.
Router	A device that directs network packets to the segment of the network for which the packet is intended, and excludes packets that are not intended for a segment. Routers reduce unnecessary network traffic and control access to segments of the network.
SPX	An abbreviation of Sequenced Packet Exchange. SPX is part of NetWare. It makes sure that packets are received in the correct order and that there are no errors.
Subnet Mask	There are approximately 4.3 billion different addresses in the IP Address range of 000.000.000.000 to 255.255.255.255. These addresses can be divided into smaller, and much more manageable subnetworks, or subnets. The Subnet Mask identifies which part of the IP Address contains the Subnet Address and which part contains the host (or device) address.
TCP/IP	An abbreviation of Transmission Control Protocol / Internet Protocol. TCP/IP is a set of communications protocols that is supported by a variety of computer platforms. TCP controls the data transfer and IP controls the routing of the data. The IP Address is a unique address that identifies a device in a network. The IP Address has to be set in the machine by the Key Operator. The IP Address consists of four bytes of information and is expressed as decimal numbers with the bytes separated by dots, for example 13.1.188.2.
TIFF	An abbreviation of Tagged Image File Format. A standard file format commonly used for scanning. Images scanned with the machine are captured in a TIFF 6.0 file format.
Twisted Pair	See 10Base-T.

15 Index

C

CentreWare Internet Services	91
CentreWare Internet Services Environments	92
Information Checklist	91
Network Communication Setup	93
Test Access	94
Changing the Settings	27

E

E-mail	105
E-mail Environments	106
Information Checklist	105
Mail Notice Service	105
Network Communications Setup	107
Scan to E-mail	105
Test Mail	109
Ethernet Port	28
EtherTalk	59
EtherTalk Environments	60
Information Checklist	59
Network Communication Setup	60
Test Print	62
Workstation Setup	62

I

IPP (Internet Printing Protocol)	85
Information Checklist	85
Network Communication Setup	87
Test Print	88
Workstation Setup	88

M

Machine Components	13
Microsoft Networking	63
Changing the Settings	68
config.txt	68
Information Checklist	63
Network Communication Setup	65
SMB Environments	64
SMB Installation	65
Test Print	67
Workstation Setup	67

N

NetWare	33
---------------	----

Information Checklist	33
NetWare Environments	34
NetWare Setup	37
Network Communication Setup	35
Test Print	37
Workstation Setup	37

P

Parallel Port	77
Information Checklist	77
Parallel Port Communication Setup	78
Parallel Port Environment	78
Test Print	79
Workstation Setup	79
PCL Resident Fonts	28
Powering Off	14
Powering On	14
Problem Solving	111
CentreWare Internet Services	125
EtherTalk	124
Mail Notice Service	127
NetWare	112
SMB	117
UNIX	119
Windows	121

S

Symbol Set	30
------------------	----

T

TCP/IP (LPD or Port9100)	71
Information Checklist	71
Network Communication Setup	73
TCP/IP (LPD or Port9100) Environments	72
Test Print	75
Workstation Setup	75

U

UNIX TCP/IP	39
-C Option	54
HP-UX	46
Information Checklist	39
Network Communication Setup	41
Printer Status	52
Printing	48
Solaris	44

SunOS	44
Test Print	47
UNIX TCP/IP Environments	40
Workstation Setup	42
USB Port	81
Information Checklist	81
Test Print	84
USB Port Communication Setup	83
USB Port Environment	82
Workstation Setup	83

X

Xerox Welcome Center	9
----------------------------	---